



Structural Product Guide

Global leaders in the supply of Engineer
Designed Fibreglass Reinforced Plastic (FRP)
Structural Profiles and Solutions

The Treadwell team is delighted to introduce the latest revision of our ArchitEX™ Structural Product Guide, showcasing the largest range of Fibreglass Reinforced Plastic (FRP) profiles in the market and the ultimate tool for designing FRP structures.

The data in this FRP Structural Product Guide has been collated to ensure that engineers and architects have the ideal reference available to them while designing structures that incorporate FRP pultrusions.

While this guide offers a huge resource of information and statistics relevant to FRP structural profiles, it is impossible to embrace the flexibility and constant evolution of the ArchitEX™ FRP composite range in one publication. To ensure that you have the most up to date information on the ArchitEX™ range of profiles and applications or to simply draw on our team's experience in this unique industry, contact us via the relevant numbers or visit www.treadwellgroup.com.au.

This product guide is also available online, so if you are concerned that your copy may not be the latest, you can request an updated hardcopy or download it at www.treadwellgroup.com.au.

A BRIEF HISTORY

Treadwell Group is one of the most established names in the supply of Access Systems throughout Australia. Our centrally located Adelaide fabrication facility, coupled with our second to none distribution network across Australia, and our commitment to quality and testing, allows our technical staff to provide engineering and design assistance for any project.

With a broad history of installation in a wide range of challenging applications, including industrial process plants, mining applications, marine and coastal environments, as well as public infrastructure, Treadwell has the experience to help you specify the right resin systems and products every time.

If you have any unique design problems, chances are we've encountered something similar before. Get in contact today.

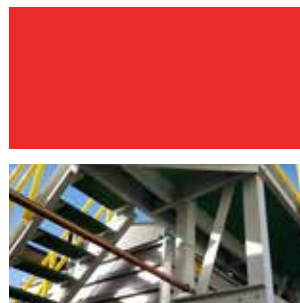

Treadwell Group Pty Ltd

Australia
P 1800 246 800
sales@treadwellgroup.com.au
treadwellgroup.com.au

New Zealand
P 0800 244 600
sales@treadwellgroup.co.nz
treadwellgroup.co.nz

ArchitEX™

Benefits of FRP Composite

- Strong
- Lightweight
- Corrosion resistant
- Dimensionally stable
- Low maintenance
- EMI/RFI Transparent
- Low thermal
- Electrical conductivity

Colour Matching

We can match any colour you need.



Scope of Shapes

Easy integration to various parts due to the capability to essentially shape any item with a constant cross section which can be pultruded.

Composite Design Engineering

A standard shape customised into a pultrusion by modifying the resin or reinforcement to achieve a particular customer need.

Optimising Resins

Standard resins can be modified or special resins can be used to maximise performance of the pultrusion in challenging environments, such as those found in high temperature or extremely corrosive areas. Typical resins include polyesters, vinyl esters, PVC, epoxies, phenolics, urethanes and blends.

Choice of Reinforcements

The type, form, placement and quantity of reinforcements can be customised to optimise economy, develop ascribed strength and create or enhance other physical characteristics of a pultruded part. Typical reinforcements used include glass or carbon fibres in multifilament strands, mat (long fibres held together with a resinous binder) or stitched fabrics.



Oil and Gas



Water and Waste Water

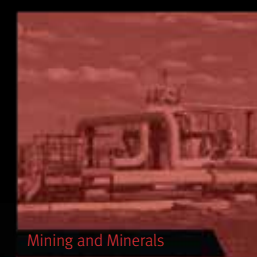

Mining and Minerals



Aquaculture

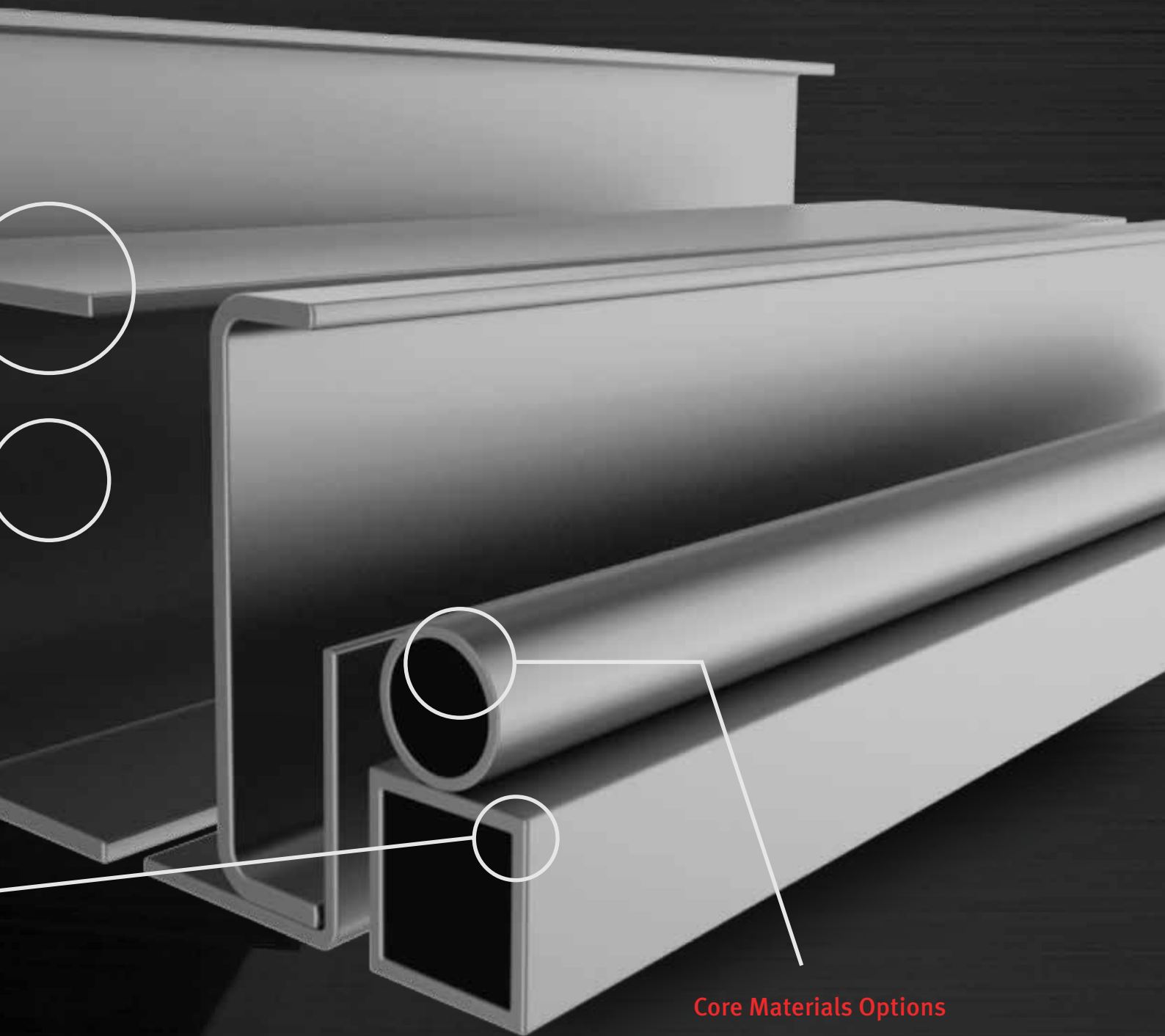

Core Materials Options

Treadwell provides a range of core material options with comprehensive experience in pultruding over various materials including foam, balsa, polyethylene and aluminium.





	Section One: Introduction to Pultrusions
06	Composition of Pultrusions
07	Resin Systems
08	The Pultrusion Process
09	Environmental Conditions
	Section Two: Coupon Properties
10	ArchitEX™ Profiles
11	Typical Properties of Threaded Rod/Nuts
11	Typical Properties of Rod, Bar and Flat Sheet
12	Typical Coupon Properties of Flat Sheet
13	Comparison
	Section Three: General Tolerances
15	Cross Sectional Tolerance
16	Flatness
17	Straightness
18	Twist
18	Angularity
18	Cut Lengths
18	Squareness of Endcut
	Section Four: Sectional Properties
20	Elements of Sections of Structural Shapes
21	C Section
23	I Section
25	WF Section
26	Double Web Section
26	Double Web Beam
27	Unequal Leg Angle
28	Equal Leg Angle
29	Rectangular Hollow Section
31	Circular Hollow Section
32	Solid Bar
33	Circular Round Bar
34	Embedment Angle
35	Square Hollow Section
37	Flat Sheet



Quality Policy

Quality is at the forefront of Treadwell Access Systems' working practices. With over 15 years of manufacturing to the highest quality standards, Treadwell Access Systems prides itself on its implementation of strict quality control measures, and strives to supply products that surpass customers' expectations. The company works on a policy of continuous improvement.



Environmental Policy

Treadwell Access Systems is conscious of the impact it has on the environment and its associated responsibilities. The company is committed to ensuring its operations satisfy both legal obligations and moral duties. Treadwell has been committed to sustainability for many years and is not just responding to current trends.

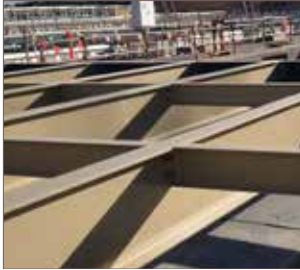

Section Five: Beams - Allowable Uniform Loads

39	Elements of Sections of Beams
40	Allowable Uniform Loads Tables
42	Technical Data Tables - C Section
56	Technical Data Tables - I Section
67	Technical Data Tables - WF Section
75	Technical Data Tables - Double Web Section
79	Technical Data Tables - Rectangular Hollow Section
85	Technical Data Tables - Square Hollow Section
99	Technical Data Tables - Interlocking Deckboard
107	Technical Data Tables - Flat Sheet

Section Six: Columns

115	Columns
-----	---------

Section Seven: Columns - Allowable Concentric Axial Stresses and Loads

118	Technical Data Tables - Angle
129	Technical Data Tables - I Section
143	Technical Data Tables - WF Section
153	Technical Data Tables - Double Web Section
155	Technical Data Tables - Square Hollow Section
174	Technical Data Tables - Rectangular Hollow Section

Section Eight: SPACE GASS Input Guide

180	SPACE GASS Input Guide
-----	------------------------

Section Nine: Corrosion Guide

182	Corrosion Guide
185	Colour Options

Disclaimer: The information contained in this Treadwell design guide herein supplied is as a service to our customers and is intended to be used only as a general guide. It is not a substitute for proven engineering practices and designs.

Introduction to Pultrusions

Composition of FRP Pultrusions

What are Pultrusions made of?

Pultrusions are composed of two key elements; glass fibre products and resin formulations. The glass contributes its inherent tensile flexural strength while the addition of resin ensures impact and corrosion resistance.

The glass fibre component normally consists of two different arrangements: glass roving which is unidirectional, and continuous mat which can be arranged in different ways to provide bi-directional stability as well as contributing to longitudinal strength properties.

Another integral part of a pultrusion is the surface veil which provides enhanced UV protection, corrosion resistance and aesthetics.

Roving

Roving is made up of fibreglass unidirectional filaments which are manufactured on continuous rolls. Roving is usually the principal element in a pultrusion, comprising 50% - 70% percent of the total glass content.

While supplying the necessary strength to pull the profile during manufacture, the roving also provides unsurpassed tensile and flexural properties. The percentage of roving in a pultrusion is the major variable in section stiffness.

Mat

Continuous strand mat constitutes the remainder of the glass reinforcement used in the pultrusion process. This would typically be 30% - 50% of the total glass content. It is important to differentiate between continuous strand mat and other hand-laid-up or press-moulded processes that utilise short chopped fibres. The mat that is used in the pultrusion process requires good tractive strength to ensure that it enters the die properly.

Fibreglass continuous strand mat is predominately applied to obtain the desired transverse properties of the product, whereas roving provides longitudinal stability to a section. Roving lacks the required lateral cohesion that is also an essential element in maintaining the maximum strength from a profile, it is the continuous strand mat that is principally responsible for this.

Surface Veil

Veils are utilised to enhance the surface properties of pultruded profiles. Most widely used today are synthetic variations which enhance the UV resistance properties and aesthetics. The veil also increases the resin content of the surface of the pultrusion which provides added corrosion resistance. The veil protects the section against moisture and therefore the mechanical characteristic values remain unchanged for sustained end-use conditions.

Cross Section of Pultrusion

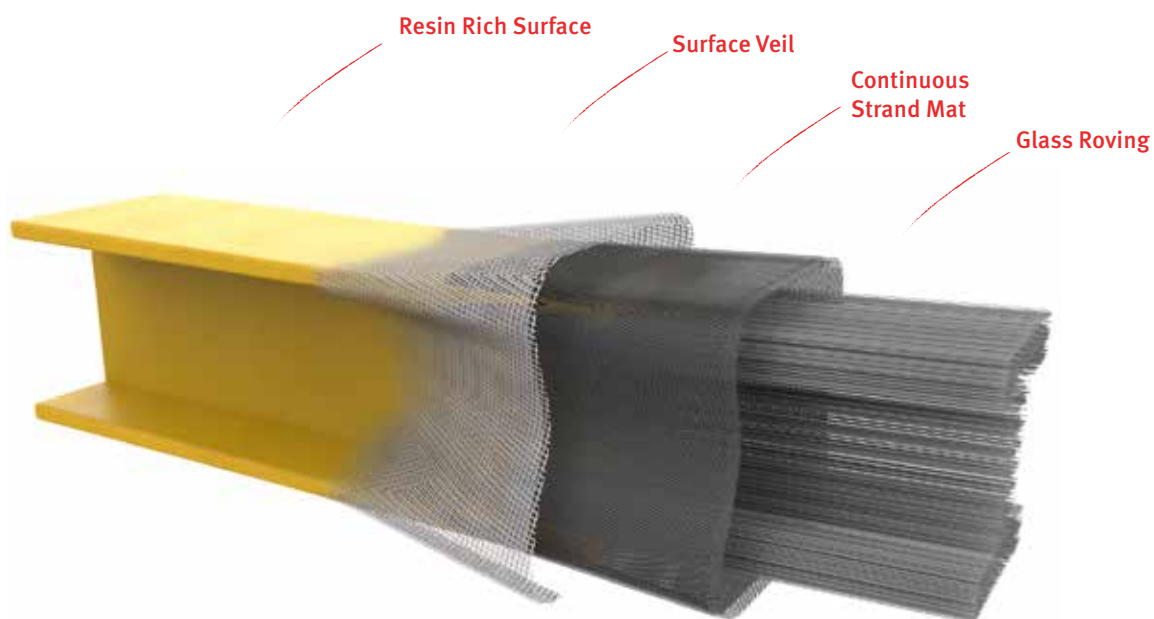

Resin Systems

When choosing a resin type for your application, we highly recommend you consult with us in relation to the application to ensure the correct resin is specified. Considerations such as corrosion, environment, temperature, fire resistance, smoke and smoke toxicity requirements must be taken into account, and will dictate which resin system should be utilised for optimum performance over time. Below is an overview of the resin systems offered in the ArchitEX™ range.

O-Series® is an architectural grade polyester resin system with an intermediate level of chemical resistance, and is a good choice for commercial or light industrial applications, especially in areas where moisture is prevalent. O-Series® is often utilised for public infrastructure applications where it has been proven to outperform traditional timber decking products. This system is available with or without fire retardant additives.

I-Series® is a premium isophthalic resin system. This system provides an intermediate level of chemical resistance and is the correct choice for areas subjected to splash and spill contact with harsh chemicals. This system is an excellent general purpose resin and is a more favourably priced alternative to the vinyl ester system. This system has a flame spread of 25 (approximately 15) or less.

V-Series® Vinyl ester resin is the most high quality chemical resistant system offered in the industry and has been developed for use in environments where FRP products are subject to frequent and direct contact with the harshest of chemical, including a broad range of acids and caustics. This system has a flame spread of 25 (approximately 15) or less.

P-Series® The phenolic resin system is a system designed specifically for use where fire resistance, low smoke and low toxic fumes are critical. P-Series® is typically used in offshore applications and confined spaces where such criteria are an absolute necessity. This system is tested in accordance with ASTM E-84. Various products also conforming to US Coast Guard Approvals, Level 2 and 3, are also offered by Treadwell. This particular resin system has a flame spread rating of 5 and a smoke density rating of 5.

Standards Resin Systems Comparison Chart

	Chemical Resistance	Fire Retardance	Low Smoke	Halogen Free	Temperature Performance
O-Series® Polyester	● ● ●	● ● ● ●	—	—	● ● ●
I-Series® Isophthalic	● ● ● ● ●	● ● ● ● ●	—	—	● ● ● ●
V-Series® Vinyl Ester	● ● ● ● ●	● ● ● ● ●	—	—	● ● ● ● ●
P-Series® Phenolic	● ● ● ●	● ● ● ● ●	● ● ● ●	● ● ● ● ●	● ● ● ● ●

ArchitEX™ Features and Benefits vs. Traditional Alternatives

	ArchitEX™	Stainless Steel	Galvanised Steel	Aluminium	Polyurethane
Chemical Resistance	● ● ● ● ●	● ● ● ●	●	● ● ●	● ● ● ●
Strength	● ● ● ● ●	● ● ● ● ●	● ● ● ● ●	● ● ● ● ●	● ● ●
Lightweight	● ● ● ● ●	●	●	● ● ● ● ●	● ● ●
Electrical Resistance	● ● ● ● ●	●	●	●	● ● ● ● ●
Cost Effectiveness	● ● ● ● ●	● ● ●	● ● ● ●	● ●	● ● ● ● ●

Introduction to Pultrusions

The Pultrusion Process

How the Pultrusion Machine Works

Pultruding is the process that is used to form continuous structural profiles out of fibreglass and resin composites. The process is performed by a pultrusion machine. The first pultrusion process was developed in the mid-1940s with further major development and greater recognition in the mid-1950s.

The term pultrusion was derived from a combination of the word pull and extrusion. There are some parallels between the two processes given that they both produce continuous profiles and involve some sort of forming die. The main difference being that the pultrusion process utilises a series of pullers, which draw the product through the entire process as compared to extruding, which uses pressure or a pushing force.

The pultrusion process commences with fibreglass roving being pulled off rolls, through a guide and then being combined with the continuous strand mat. It is this fibreglass component that provides the resistance to tension that is necessary in the pultrusion process. The raw fibre is pulled through a series of guides or rollers and then enters a resin impregnation bath. The resin is usually a thermo-setting resin.

Now that the fibres are thoroughly 'wetted out' with the resin, they pass through a series of tooling which arranges the fibres correctly and removes excesses of resin. This set of tooling and guides is referred to as the pre-former. At this stage, the surface veil is added.

The uncured composite is then pulled into a heated die which commonly consists of 2-3 differing stages of temperature which initiate the curing of the resin component. The profile that exits the die is now a cured pultruded fibreglass reinforced plastic composite.

It is this rigid profile that is gripped further down the line by the pulling mechanism which provides steady and continuous tractive effort. After passing through the pullers, the FRP profile reaches a cut-off saw. The saw cuts the pultrusion to the desired length without slowing or halting the process.

This way high strength and lightweight profiles can be created from fibreglass reinforced plastic to virtually any length required.

Pultrusion Machine

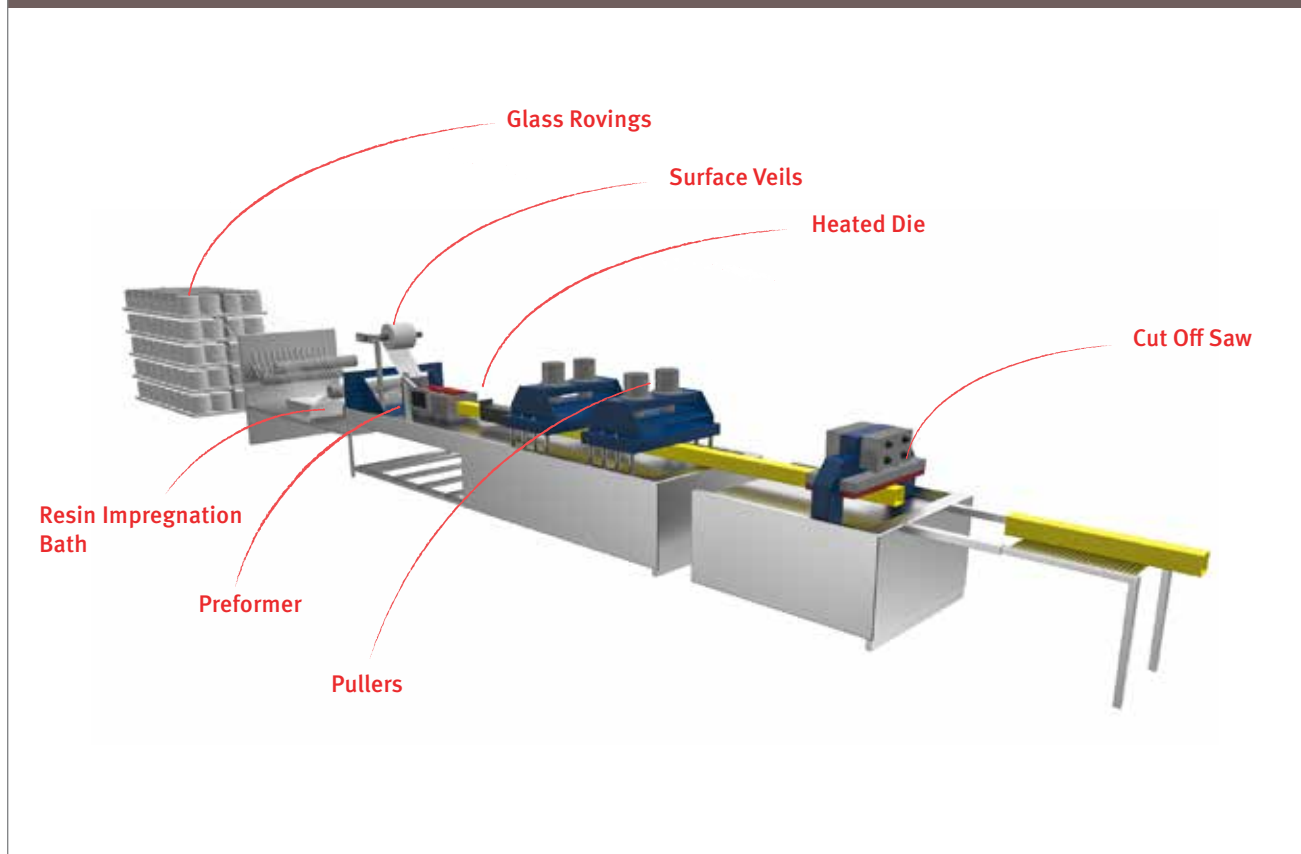

Environmental Conditions

Temperature

When designing a structure that is going to incorporate FRP sections, it is essential to consider environment changes such as temperature. Continued exposure to elevated temperatures can cause polyester and Vinyl Ester fibreglass pultrusions to lose certain percentages of their properties.

These tables shows the percentage of property retention when exposed to certain continuous temperatures.

Ultimate Stress

Temperature	Polyester	Vinyl Ester
37°C	85%	90%
51°C	70%	80%
65°C	50%	80%
79°C	Not Recommended	75%
93°C	Not Recommended	50%

Modulus of Elasticity

Temperature	Polyester	Vinyl Ester
37°C	100%	100%
51°C	90%	95%
65°C	85%	90%
79°C	Not Recommended	88%
93°C	Not Recommended	85%

Weathering

As with most plastic products, fibreglass reinforced pultrusions will undergo some form of visual degradation when exposed to outdoor weathering.

Typically, the surface of ArchitEX™ Pultrusions have good water and ambient temperature resistant properties but are susceptible to ultra-violet (UV) light. UV light is the light spectrum between 290 and 400 nanometres. This light has a higher energy and causes significant degradation to polymers by breaking chemical bonds or starting chemical reactions. The fire retardant polyester formulations contain a halogen which makes these plastics typically more susceptible to UV light degeneration.

Deterioration that has been caused by UV light can be identified by 'fade' and 'yellowing' on the pultrusion surface. Over an extended period of exposure, the actual glass fibres closest to the surface will become exposed. This state is known as fibrebloom and does not directly or immediately affect the physical properties of the section.

Treadwell adds a UV stabiliser into the resin formulation. This is especially important due to the extreme exposure that our products experience in the Pacific region. Also, to ensure that our pultruded products endure a protracted lifespan, we use high quality polyester surface veils to ensure that the structural component of the composite is protected as well as possible from damaging and corroding elements.

The ArchitEX™ range is also offered with a range of exterior coatings to enhance aesthetics. If a urethane coating is applied, this will also provide a hugely effective protection barrier to outdoor weathering.

Pultrusion Availability

Treadwell is arguably the largest stockist of FRP pultrusion products in Australia. We always stock a comprehensive range of I-Beam, C Section, Hollow Section and Angle products which are commonly in high demand. Due to the consistent and rapid evolution of the fibreglass pultrusion market, we are continually reevaluating our range of stocked products to ensure that our holdings accurately reflect customer demand.

We utilise efficient transport networks across Australia to ensure rapid delivery to remote locations and stock products in most capital cities.

Our complete range of products available is listed in the Section Properties tables. To obtain price and availability or find out if the product you require is a stock item, call Treadwell on 1800 246 800.



Coupon Properties

ArchitEX™ Profiles

The test results for typical coupon properties of Treadwell’s structural fibreglass profiles are shown below. Properties are obtained via the ASTM test method shown. Ultraviolet inhibitors and synthetic surfacing veils come as standard.

Mechanical Properties	ASTM	Units	Value
Tensile Stress, LW	D-638	MPa	206.8
Tensile Stress, CW	D-638	MPa	48.2
Tensile Modulus, LW	D-638	GPa	20.7
Tensile Modulus, CW	D-638	GPa	5.5
Compressive Stress, LW	D-6641	MPa	206.8
Compressive Modulus, LW	D-6641	GPa	20.7
Compressive Modulus, CW	D-6641	GPa	6.9
In-Plane Shear Modulus	D-5379	GPa	3.1
Interlaminar Shear Strength	D-2344	MPa	31.0
In-Plane Shear Strength	D-5379	MPa	68.9
Pin-bearing Strength, LW	D-953 ^A	MPa	144.8
Pin-bearing Strength, CW	D-953 ^A	MPa	124.1

Thickness of Profile (mm)	ASTM Required	Strength (kN)
t=9.525mm	TBC	2.9
t=12.7mm	TBC	4.0
t=19.05mm	TBC	5.6

Pull-through Strength Per Fastener

*The pull-through strength per fastener corresponds to the thickness and the ASTM required.
For example, when ASTM required is D-790 and t= 9.525mm, the pull-through strength is 2.9kN.

Physical Properties	ASTM	Units	Value
Barcol Hardness	D-2583	----	45
24 Hour Water Absorbtion	D-570	% max.	0.45
Density	D-792	g/cc	1.72-1.94
Coefficient of Thermal Expansion, LW	D-696	10 ⁻⁶ mm/mm/°C	12
Glass Transition Temperature	D-4065	°C	83

Electrical Properties	ASTM	Units	Value
Arc Resistance, LW	D-495	seconds	120
Dielectric Strength, LW	D-149	kv./mm	1.37
Dielectric Strength, PF	D-149	volts/mil.	200
Dielectric Constant, PF	D-150	@60hz	5

Fire Retardant Polyester and Fire Retardant Vinyl Ester Structural Profiles:

Flammability Properties	ASTM	Units	Value
Tunnel Test	E-84	Flame Spread	25 max.
Flammability	D-635	----	Nonburning
UL	94	VO	----
NBS Smoke Chamber	E-662	Smoke Density 600-700	----

CW = Crosswise

LW = Lengthwise

PF = Perpendicular to Laminate Face

Typical Properties of Threaded Rod / Nuts

Treadwell Group's threaded rod and nuts are manufactured using premium vinyl ester resin containing UV inhibitors. The properties listed below are the result of the ASTM test method indicated.

Properties	ASTM	Units	Diameter - Threads per Inch (UNC)					
			9.5mm	12.7mm	15.9mm	19.0mm	25.4mm	
Ultimate Transverse Shear (Double Shear)	B-565	Newton	18,680	30,240	44,480	59,600	106,750	
Longitudinal Compressive Strength	D-695	MPa	344	344	344	344	344	
Flexural Strength	D-790	MPa	482	482	482	482	482	
Flexural Modulus	D-790	GPa	17.2	17.2	17.2	17.2	17.2	
Flammability	D-635	Self-extinguishing for all						
Fire Retardant	Class 1							
Water Absorption (24 hr. immersion)	D-570	% max.	0.8	0.8	0.8	0.8	0.8	
Longitudinal Coefficient of Thermal Expansion	D-696	10 ⁻⁶ mm/mm/°C	11	11	11	11	11	
Ultimate Thread Shear (using fibreglass nut)	---	Newton	5,337	10,670	16,010	17,790	36,470	
Ultimate Torque Strength (fibreglass nut lubricated with SAE 10W30 motor oil)		NewtonMeter	10	21	47	67	149	
Rod Weight	---	Kg./m	0.104	0.119	0.297	0.447	0.789	
Nut Weight	---	grams	4.5	9.1	18.1	27.2	63.6	
Nut Dimensions	---	mm.(square) x mm.(thick)	17.2 X 11.4	21.8X 14.2	26.9 X 17.5	31.5 X 20.8	41.4 X 27.9	
Color	Gray							

Typical Properties of Rod, Bar, and Flat Sheet

Below are test results for typical coupon properties of Treadwell Group's Rod, Bar, and Flat Sheet reinforced with all unidirectional longitudinal fibreglass roving. Properties are derived per the ASTM test method shown.

Properties	ASTM	Units	Rod	Bar	Flat Sheet
Tensile Stress	D-638	MPa	620.5	165.5	620.5
Tensile Modulus	D-638	GPa	34.7	27.6	34.7
Compressive Stress	D-695	MPa	413.7	344.7	344.7
Flexural Stress	D-790	MPa	689.5	620.5	689.5
Flexural Modulus	D-790	GPa	41.4	31.0	31.0
Barcol Hardness	D-2583		60	60	60
Izod Impact	D-256	J/mm	2.14	2.14	2.14
Density	D-792	gr/cc	1.80-2.07	1.80-2.07	1.80-2.07
Water Absorption (24 hour)	D-570	%	0.2	0.2	0.2

Coupon Properties

Typical Coupon Properties of Flat Sheet

The test results for typical coupon properties of Treadwell's fibreglass flat sheets are shown below. Properties are obtained via the ASTM test method shown. Ultraviolet inhibitors and synthetic surfacing veils come as standard.

Mechanical Properties	ASTM	Units	Thickness					
			STD & FR			VE		
			3.2	4.8 - 6.4	9.5 - 25.4	3.2	4.80 - 6.4	9.5 - 25.4
Tensile Stress, LW	D-638	MPa	165.5	165.5	165.5	165.5	165.5	165.5
Tensile Stress, CW	D-638	MPa	51.7	68.9	68.9	51.7	68.9	68.9
Tensile Modulus, LW	D-638	GPa	13.8	13.8	13.8	13.8	13.8	13.8
Tensile Modulus, CW	D-638	GPa	6.9	7.6	9.6	6.9	7.6	9.6
Compressive Stress, LW	D-6641	MPa	165.5	165.5	165.5	165.5	165.5	165.5
Compressive Stress, CW	D-6641	MPa	106.9	113.8	113.8	113.8	120.7	120.7
Compressive Modulus, LW	D-6641	GPa	12.4	12.4	12.4	12.4	12.4	12.4
Compressive Modulus, CW	D-6641	GPa	6.9	6.9	6.9	6.9	6.9	6.9
Flexural Stress, LW	D-790	MPa	241.3	241.3	206.8	241.3	241.3	206.8
Flexural Stress, CW	D-790	MPa	103.4	103.4	124.1	103.4	103.4	124.1
Flexural Modulus, LW	D-790	GPa	11.0	13.8	13.8	11.0	13.8	13.8
Flexural Modulus, CW	D-790	GPa	6.2	7.6	9.6	6.2	7.6	9.6
In-Plane Shear Strength	D-5379	MPa	41.3	41.3	41.3	41.3	41.3	41.3
In-Plane Shear Modulus	D-5379	GPa	2.76	2.76	2.76	2.76	2.76	2.76
Interlaminar Shear Strength	D-2344	MPa	24.1	24.1	24.1	24.1	24.1	24.1
Pin-bearing Strength, LW	D-953 ^A	MPa	144.8	144.8	144.8	144.8	144.8	144.8
Pin-bearing Strength, CW	D-953 ^A	MPa	89.7	89.7	89.7	89.7	89.7	89.7

Thickness of Profile (mm)	ASTM Required	Strength (kN)
t=9.525mm	TBC	2.9
t=12.7mm	TBC	4.0
t=19.05mm	TBC	5.6

Pull-through Strength Per Fastener

*The pull-through strength per fastener corresponds to the thickness and the ASTM required.
For example, when ASTM required is D-790 and t= 9.525mm, the pull-through strength is 2.9kN.

Physical Properties								
Barcol Hardness	D-2583	---	40.0	40.0	40.0	40.0	40.0	40.0
24 Hour Water Absorption	D-570	% max.	0.6	0.6	0.6	0.6	0.6	0.6
Density	D-792	g/cc	1.72 - 1.94	1.72 - 1.94	1.72 - 1.94	1.72 - 1.94	1.72 - 1.94	1.72 - 1.94
Coefficient Thermal Expansion, DW	D-696	10 ⁻⁶ mm/mm /°C	8.0	8.0	8.0	8.0	8.0	8.0
Glass Transition Temperature	D-4065	°C	83	83	83	83	83	83

Electrical Properties								
Arc Resistance, LW	D-495	seconds	120.0	120.0	120.0	120.0	120.0	120.0
Dielectric Strength, LW	D-149	kv./mm	1.37	1.37	1.37	1.37	1.37	1.37
Dielectric Strength, PF	D-149	volts/mil.	200.0	----	----	200.0	----	----

Flammability Properties For FR and VE		
Tunnel Test	E-84	Flame Spread 25 max.
Flammability	D-635	Non-burning
UL	94	VO
NBS Smoke Chamber	E-662	Smoke Density 600-700

CW	Crosswise
LW	Lengthwise
PF	Perpendicular to Laminate Face



COMPARE		
	ArchitEX™	vs Steel
Corrosion Resistance	ArchitEX™ is available in either polyester or vinyl ester resin for resistance to a broad range of chemicals. Painting is beneficial in assisting with UV resistance when subjected to prolonged exposure.	Subject to oxidation and corrosion. Requires painting or galvanizing for many applications.
Weight	Lightweight - weight 25% as much as steel. 12.7mm thick plate = 22.95 kg/m ²	Could require lifting equipment to move and place. 12.7mm thick plate = 99.6 kg/m ²
Conductivity	Low electrical conductivity properties - high dielectric capability Low thermal conductivity 4 (BTU/SF/HR/F°/IN).	Conducts electricity. Potential Shock Hazard Thermal Conductivity 260-460 (BTU/SF/HR/F°/IN).
Strength	ArchitEX™ has a high strength-to-weight ratio and pound-for-pound is stronger than steel in the lengthwise direction. Tensile strength = 206.8MPa , CW = 48.2MPa	Homogeneous material. Tensile strength = 413.7MPa Yield strength = 248.2MPa
Stiffness	Modulus of Elasticity = 17.2GPa Will not permanently deform under working load.	Flexural modulus = 200MPa Modulus of Elasticity = 200GPa
Impact Resistance	Glass mats in ArchitEX™ distributes impact load to prevent surface damage. Will not permanently deform under impact.	Can permanently deform under impact.
EMI/RFI Transparency	Transparent to EMI/RFI transmissions.	Can interfere with EMI/RFI transmissions.
Versatility	Pigments added to the resin provide color throughout the part. Special colors available.	Must be painted for color. To maintain color and corrosion resistance, repainting may be required.
Easy Field Fabrication	ArchitEX™ can be field fabricated using simple carpenter tools with carbide or diamond tip blades. Lightweight for easier erection and installation.	Often requires welding and cutting torches. Heavier material requires special handling equipment to erect and install.
Cost	Lower installation and maintenance costs in industrial applications often equals lower lifecycle costs.	Lower initial cost.



General Tolerances

Cross Sectional Tolerances

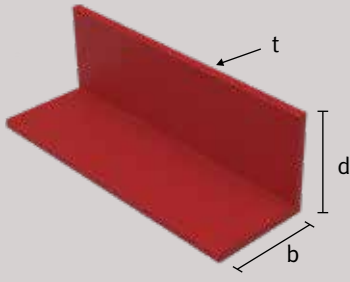
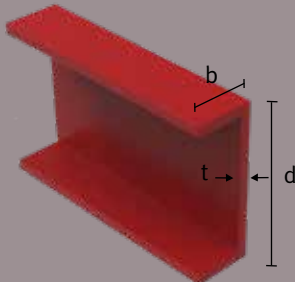
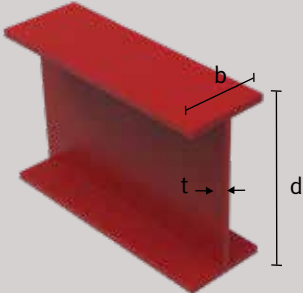
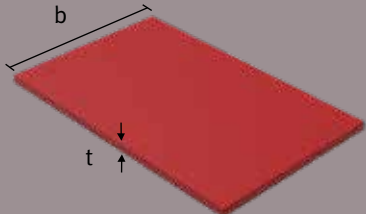
Shapes	Dimension	Tolerance % of Nominal	* Maximum or Minimum Tolerances	
Angles 	t = thickness	± 10 %	± 0.26mm min.	
	b = flange width	± 4 %	± 2.4mm max.	
	d = depth	± 4 %	± 2.4mm max.	
C Sections 	t = thickness	± 10 %	± 0.26mm min.	
	b = flange width	± 4 %	± 2.4mm max.	
	d = depth	± 4 %	± 2.4mm max.	
I, Wide Flange Section 	t = thickness	± 10 %	± 0.26mm min.	
	b = flange width	± 4 %	± 2.4mm max.	
	d = depth	± 4 %	± 2.4mm max.	
Flat Sheet 	t = thickness	t ≤ 3.2mm	± 15%	0.25mm min
		t ≥ 3.2mm	± 10 %	1.27mm max
	b = width	± 4 %	± 2.4mm max.	

General Tolerance

Cross Sectional Tolerance

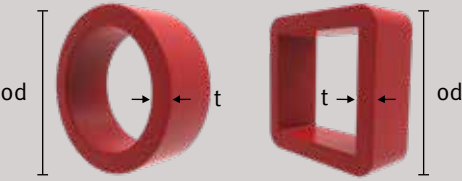
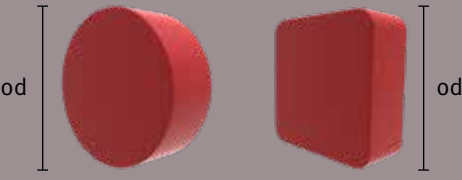
Shapes	Dimension	Tolerance % of Nominal	* Maximum or Minimum Tolerances
Closed Shapes Round, Square and Rectangular Tubes 	t = thickness	±20%	0.25mm min
	od = outside dimension	±4%	2.39mm max
Round Rod & Square Bar 	od = outside dimension	±4%	2.39mm max

Flatness

Flatness is measured in the center with the weight of the profile minimising the deviation by contact with a flat surface

Structural Shapes Rods, Bars & Flat Sheet 	Allowable deviation from flat		
	Width	All Thickness	
	Up to 25.4mm	0.2mm	
	Over 25.4mm	6.3mm	
Hollow Shapes 	Allowable deviation from flat		
	Width	Thickness under 4.8mm	Thickness 4.8mm and over
	Up to 25.4mm	0.3mm	0.2mm
	Over 25.4mm	0.3mm x width	4.8mm x width

Straightness

Straightness is measured in the centre with the weight of the pultrusion minimising the deviation by contact with a flat surface.

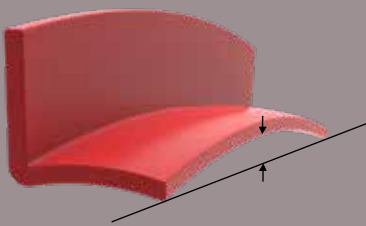
<p>Angle, Beam and C Section</p> 	Allowable deviation from straight	
	All widths	0.5 mm/m

<p>Rods and Bars</p> 	Width	Thickness	Allowable deviation from straight
	(38.1mm)	----	4.17mm/m
		2.4mm and over	3.33mm/m
(38.1mm) and over	All thickness	3.33mm/m	

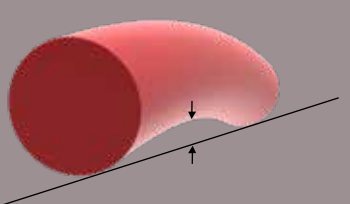
<p>Round, Square, and Rectangular Tube</p> 	Allowable deviation from straight	
	Diameter/Depth	Per Meter
	All	2.5mm

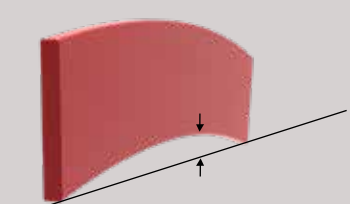
<p>Flat Sheet and Plate</p> 	Allowable deviation from straight	
	All thickness and widths	2.5mm

General Tolerance

Twist

Twist is measured with the weight of the pultrusion minimising the twist.

	Allowable twist	
Bars and other Structural Profiles other than Tubes 	0.003°/mm	
Closed Profiles (Tubes) 	0.003°/mm	

Angularity

Angularity is the angle measured between two perpendicular faces of the profile.

	Allowable deviation from specific angle	
All Profiles 	Thickness up to 19mm	2°

Cut Lengths

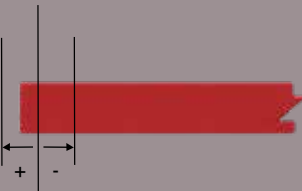
	Allowable deviation from specific length	
All Profiles 	up to 2.44m	0 + 6.35mm
	2.44m ≤ 7.32m	0 + 12.7mm
	> 7.32m	0 + 76.2mm

*All parts being cut from stock must allow for blade width

Squareness of Endcut

	Allowable deviation from specific length	
All Profiles	Profiles 50.8mm and under	± 2°
	Profiles over 50.8mm	± 1°

Sectional Properties



Sectional Properties

Elements of Sections of Structural Shapes

The section table values on the following pages have been calculated from nominal dimensions. All shapes shown in the tables are available, but not all are stocked. A shape availability list is included in the manual and, for convenience, availability information is noted on the individual uniform load tables.

Notation	
A	cross sectional area (mm. ²)
A _w	area of web (mm. ²)
b	width of section (mm.)
d	depth of section / diameter of rod (mm.)
h	depth between flanges (mm.)
I	moment of inertia (mm. ⁴)
J	torsion constant (mm. ⁴)
od	outside diameter of tube (mm.)
r	radius of gyration mm.)
S	section modulus (mm. ³)
t	thickness (mm.)
t _b	thickness of width dimension (mm.)
t _f	thickness of flange (mm.)
t _d	thickness of depth dimension (mm.)
t _w	thickness of web (mm.)
Wt.	weight of section (kg./m.)
C _x	x coordinate of centroid (mm.)
C _y	y coordinate of centroid (mm.)

Sectional Properties - C Section

The section values shown on this page have been calculated from the nominal dimensions of the profile. All the shapes listed in the table are available but not all are stocked. For information on availability and price, contact Treadwell Group on 1800 246 800.

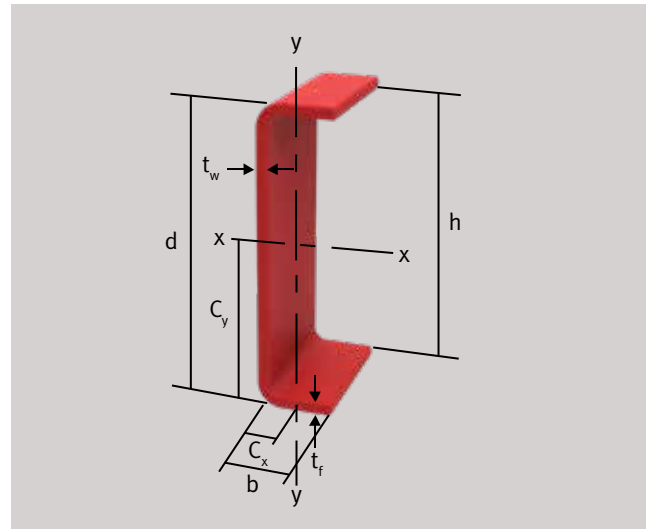

C Section		Sectional Dimensions						
Part	Part Number	d mm	b mm	t _w mm	t _f mm	h mm	C _x mm	C _y mm
		Web	Flange					
50.8 x 14.2 x 3.2mm	ARX-CS0511403	50.8	14.2	3.2	3.2	44.8	3.8	25.4
76.2 x 22.2 x 6.4mm	ARX-CS0762206	76.2	22.2	6.4	6.4	63.5	6.4	38.1
76.2 x 25.4 x 6.4mm	ARX-CS0762506	76.2	25.4	6.4	6.4	63.5	7.4	38.1
76.2 x 38.1 x 6.4mm	ARX-CS0763806	76.2	38.1	6.4	6.4	63.5	11.8	38.1
88.9 x 3.2 x 30.2 x 4.8mm	ARX-CS0893005	88.9	30.2	3.2	4.8	79.4	8.8	44.5
88.9 x 38.1 x 4.8mm	ARX-CS0893805	88.9	38.1	4.8	4.8	79.4	10.5	44.5
101.6 x 28.6 x 6.4mm	ARX-CS1022906	101.6	28.6	6.4	6.4	88.9	7.5	50.8
101.6 x 34.9 x 4.8mm	ARX-CS1023505	101.6	34.9	4.8	4.8	92.1	8.9	50.8
139.7 x 38.1 x 6.4mm	ARX-CS1403806	139.7	38.1	6.4	6.4	127.0	9.1	69.9
152.4 x 41.3 x 6.4mm	ARX-CS1524106	152.4	41.3	6.4	6.4	139.7	9.7	76.2
152.4 x 42.9 x 9.5mm	ARX-CS1524310	152.4	42.9	9.5	9.5	133.4	11.3	76.2
203.2 x 55.6 x 9.5mm	ARX-CS2035610	203.2	55.6	9.5	9.5	184.2	13.4	101.6
254 x 69.9 x 12.7mm	ARX-CS2547013	254	69.9	12.7	12.7	228.6	17.2	127.0
292.1 x 69.9 x 12.7mm	ARX-CS2927013	292.1	69.9	12.7	12.7	266.7	16.2	146.1
304.8 x 76.2 x 12.7mm	ARX-CS3057613	304.8	76.2	12.7	12.7	279.4	17.6	152.4
355.6 x 88.9 x 19.1mm	ARX-CS3568919	355.6	88.9	19.1	19.1	317.5	22.1	177.8
457.2 x 60.3 x 9.5mm	ARX-CS4576010	457.2	60.3	9.5	9.5	438.2	10.2	228.6

Sectional Properties

C Section				Section Properties							
Part	Part Number	x-x			y-y						
		I mm ⁴	S mm ³	r mm	I mm ⁴	S mm ³	r mm	J mm ⁴	A _w mm ²	Area mm ²	Weight Kg./m
50.8 x 14.2 X 3.2mm	ARX-CS0511403	74758	2943	18.0	3367	320	3.8	801	141.1	231.9	0.4
76.2 x 22.2 x 6.4mm	ARX-CS0762206	480725	12617	26.5	23434	1485	5.8	9449	403.2	685.5	1.2
76.2 x 25.4 x 6.4mm	ARX-CS0762506	530044	13912	27.0	34957	1943	6.9	9990	403.2	725.8	1.3
76.2 x 38.1 x 6.4mm	ARX-CS0763806	727320	19090	28.6	115316	4390	11.4	12335	403.2	887.1	1.6
88.9 x 3.2 x 30.2 x 4.8mm	ARX-CS0893005	641313	14428	34.5	46438	2171	9.3	2992	252.0	539.3	1.0
88.9 x 38.1 x 4.8mm	ARX-CS0893805	841417	18929	33.7	96058	3486	11.4	5810	378.0	740.9	1.3
101.6 x 28.6 x 6.4mm	ARX-CS1022906	1196122	23546	35.9	53868	2559	7.6	12998	564.5	927.4	1.7
101.6 x 34.9 x 4.8mm	ARX-CS1023505	1090307	21463	37.6	77666	2983	10.0	6064	438.5	771.2	1.4
139.7 x 38.1 x 6.4mm	ARX-CS1403806	3236630	46337	50.1	137457	4744	10.3	17957	806.5	1290.3	2.3
152.4 x 41.3 x 6.4mm	ARX-CS1524106	4239811	55640	54.8	177875	5626	11.2	19550	887.1	1411.3	2.5
152.4 x 42.9 x 9.5mm	ARX-CS1524310	6055368	79467	53.9	272708	8636	11.4	63244	1270.2	2086.7	3.8
203.2 x 55.6 x 9.5mm	ARX-CS2035610	14890522	146560	72.8	635340	15078	15.0	26711	1754.0	2812.5	5.1
254 x 69.9 x 12.7mm	ARX-CS2547013	38492696	303091	90.7	1659560	31514	18.8	254501	2903.2	4677.4	8.4
292.1 x 69.9 x 12.7mm	ARX-CS2927013	54725705	374704	103.0	1717580	31998	18.2	280536	3387.1	5161.3	9.3
304.8 x 76.2 x 12.7mm	ARX-CS3057613	64394404	422534	108.4	2246678	38310	20.2	297902	3548.4	5483.9	9.9
355.6 x 88.9 x 19.1mm	ARX-CS3568919	146822233	825770	124.7	5061997	75735	23.2	1160000	6048.4	9435.5	17.0
457.2 x 60.32 x 9.5mm	ARX-CS4576010	124352263	543972	152.9	961389	19198	13.4	160640	4173.4	5322.6	9.6

Sectional Properties – I Section

The section values shown on this page have been calculated from the nominal dimensions of the profile. All the shapes listed in the table are available but not all are stocked. For information on availability and price, contact Treadwell Group on 1800 246 800.

*457.20 I Section - Web = 9.53mm Flange = 12.70mm

*609.60 I Section - Web = 9.53mm Flange = 19.05mm

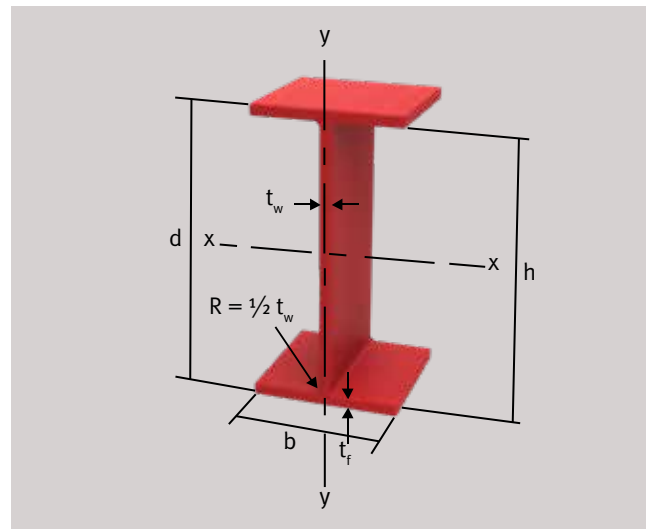

I Section		Sectional Dimensions				
Part	Part Number	d mm	b mm	t _w mm	t _f mm	h mm
		Web	Flange			
76.2 x 38.1 x 6.4mm	ARX-IS07603806	76.2	38.1	6.4	6.4	63.5
88.9 x 38.1 x 4.8mm	ARX-IS08903805	88.9	38.1	4.8	4.8	79.4
101.6 x 50.8 x 6.4mm	ARX-IS10205106	101.6	50.8	6.4	6.4	88.9
139.7 x 63.5 x 6.4mm	ARX-IS14006406	139.7	63.5	6.4	6.4	127.0
152.4 x 76.2 x 6.4mm	ARX-IS15207606	152.4	76.2	6.4	6.4	139.7
152.4 x 76.2 x 9.5mm	ARX-IS15207610	152.4	76.2	9.5	9.5	133.4
203.2 x 101.6 x 9.5mm	ARX-IS20310210	203.2	101.6	9.5	9.5	184.2
203.2 x 101.6 x 12.7mm	ARX-IS20310213	203.2	101.6	12.7	12.7	177.8
254 x 127 x 9.5mm	ARX-IS25412710	254	127	9.5	9.5	235.0
254 x 127 x 12.7mm	ARX-IS25412713	254	127	12.7	12.7	228.6
304.8 x 152.4 x 12.7mm	ARX-IS30515213	304.8	152.4	12.7	12.7	279.4
457.2 x 9.5 x 114.3 x 12.7mm	ARX-IS45711413	457.2	114.3	9.5	12.7	431.8
609.6 x 9.5 x 190.5 x 19.1mm	ARX-IS61019119	609.6	190.5	9.5	19.1	571.5

Sectional Properties

I Section		Section Properties									
Part	Part Number	x-x			y-y						
		I mm ⁴	S mm ³	r mm	I mm ⁴	S mm ³	r mm	J mm ⁴	A _w mm ²	Area mm ²	Weight Kg./m
76.2 x 38.1 x 6.4mm	ARX-IS07603806	727321	19090	28.6	59887	3144	8.2	12979	403.2	886.9	1.6
88.9 x 38.1 x 4.8mm	ARX-IS08903805	841418	18930	33.7	44614	2342	7.8	6038	378.0	740.7	1.3
101.6 x 50.8 x 6.4mm	ARX-IS10205106	1837272	36167	39.0	140641	5537	10.8	17664	564.5	1209.4	2.2
139.7 x 63.5 x 6.4mm	ARX-IS14006406	4671764	66883	53.8	273694	8620	13.0	23433	806.5	1612.5	2.9
152.4 x 76.2 x 6.4mm	ARX-IS15207606	6606590	86701	59.7	471241	12369	15.9	26694	887.1	1854.4	3.3
152.4 x 76.2 x 9.5mm	ARX-IS15207610	9301187	122063	58.5	711994	18687	16.2	86106	1270.2	2721.1	4.9
203.2 x 101.6 x 9.5mm	ARX-IS20310210	23121371	227573	79.2	1678187	33035	21.3	116564	1754.0	3688.6	6.6
203.2 x 101.6 x 12.7mm	ARX-IS20310213	29396344	289334	77.9	2250251	44296	21.6	275449	2258.1	4837.5	8.7
254 x 127 x 9.5mm	ARX-IS25412710	46462849	365849	99.9	3268728	51476	26.5	146271	2237.9	4656.1	8.4
254 x 127 x 12.7mm	ARX-IS25412713	59642495	469626	98.7	4374766	68894	26.7	346832	2903.2	6127.5	11.0
304.8 x 152.4 x 12.7mm	ARX-IS30515213	105705439	693605	119.4	7539839	98948	31.9	417940	3548.4	7417.5	13.4
457.2x9.5x114.3x12.7mm	ARX-IS45711413	207348286	907035	171.9	3191852	55850	21.3	288053	4112.9	7014.4	12.6
609.6x9.5x190.5x19.1mm	ARX-IS61019119	781189968	2562959	248.0	21990860	230878	41.6	1060000	5443.5	12698.4	22.9

Sectional Properties - WF Section

The section values shown on this page have been calculated from the nominal dimensions of the profile. All the shapes listed in the table are available but not all are stocked. For information on availability and price, contact Treadwell Group on 1800 246 800.

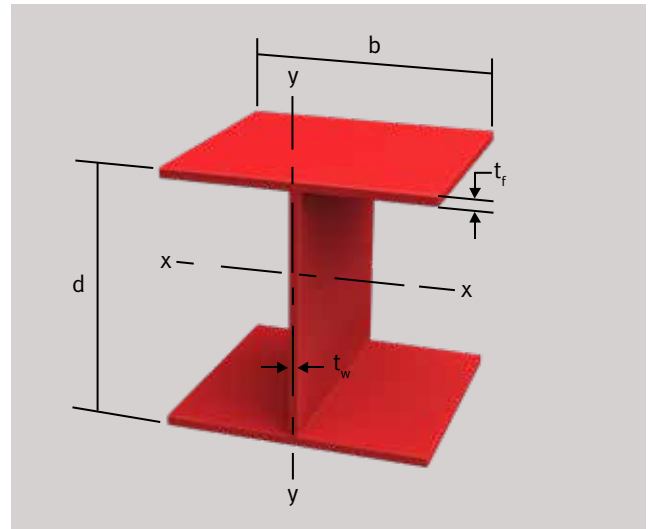

WF Section		Section Dimensions						Section Properties					
Part	Part Number	d mm	b mm	t _w mm	t _f mm	Area mm ²	Weight Kg./m	x-x			y-y		
		Web	Flange					I mm ⁴	S mm ³	r mm	I mm ⁴	S mm ³	r mm
76.2 x 6.4mm	ARX-WF07606	76.2	76.2	6.4	6.4	1374.2	2.5	1319454	34577	31.0	470342	12290	18.5
101.6 x 6.4mm	ARX-WF10206	101.6	101.6	6.4	6.4	1864.5	3.4	3304878	65057	42.2	1111338	21959	24.4
152.4 x 6.4mm	ARX-WF15206	152.4	152.4	6.4	6.4	2832.3	5.1	11771025	154530	64.5	3750245	49161	36.3
152.4 x 9.5mm	ARX-WF15210	152.4	152.4	9.5	9.5	4180.6	7.5	16720016	219423	63.2	5627449	73906	36.6
203.2 x 9.5mm	ARX-WF20310	203.2	203.2	9.5	9.5	5632.2	10.1	41285995	406399	85.6	13331893	131260	48.8
203.2 x 12.7mm	ARX-WF20313	203.2	203.2	12.7	12.7	7425.8	13.4	52844742	520125	84.3	17789731	175178	49.0
254 x 9.5mm	ARX-WF25410	254.0	254.0	9.5	9.5	7135.5	12.8	82634425	650730	107.7	26031113	205002	60.5
254 x 12.7mm	ARX-WF25413	254.0	254.0	12.7	12.7	9361.3	16.9	106638491	839673	106.9	34722026	273336	61.1
304.8 x 12.7mm	ARX-WF30513	304.8	304.8	12.7	12.7	11296.8	20.3	188323909	1236404	129.0	59983111	393617	72.9

Sectional Properties

Sectional Properties - Double Web Section

The section values shown on this page have been calculated from the nominal dimensions of the profile. All the shapes listed in the table are available but not all are stocked. For information on availability and price, contact Treadwell Group on 1800 246 800.

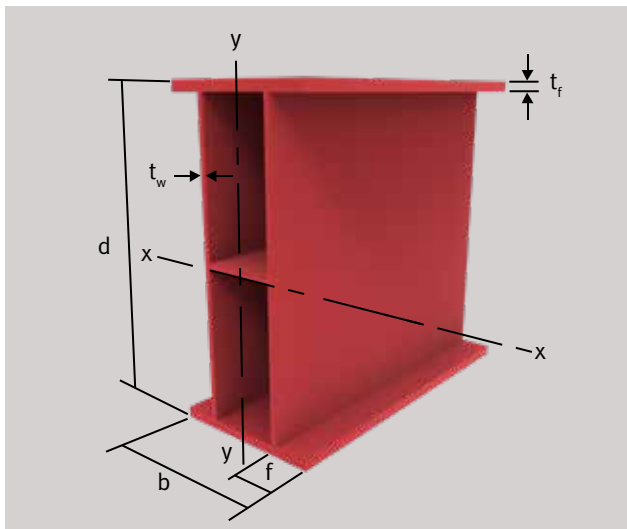

Sectional Properties - Double Web Section

The section values shown on this page have been calculated from the nominal dimensions of the profile. All the shapes listed in the table are available but not all are stocked. For information on availability and price, contact Treadwell Group on 1800 246 800.

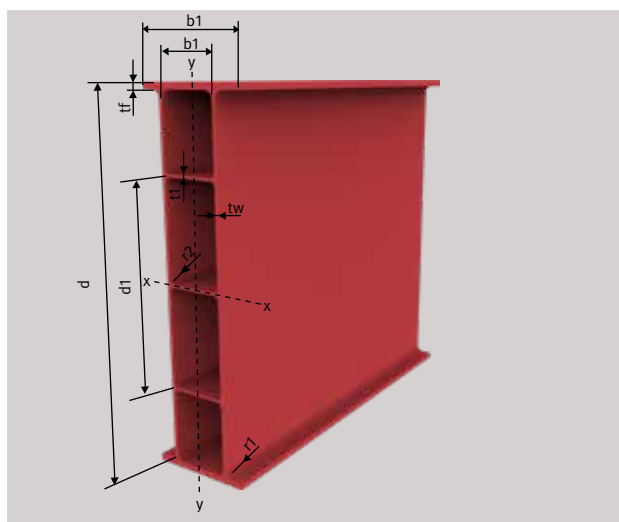

Double Web Section		Section Dimensions									
Part	Part Number	d mm	d_1 mm	b mm	b_1 mm	t_w mm	t_f mm	t_1 mm	r_1 mm	r_2 mm	
		Web		Flange							
475mm X 225mm	ARX-DW4752251016	475	/	225	115	10	16	10	5	5	
610mm X 203mm	ARX-DW6102030810	609.6	355.6	203.2	101.6	8	18	6	19.1	12.7	
914mm X 254mm	ARX-DW9142540916	914.4	508	254	152.4	8.5	16	6.4	19.1	12.7	

Double Web Section		Section Properties									
Part	Part Number	x-x				y-y				Area mm ²	Weight kg/m
		I mm ⁴	S mm ³	r mm	A_w mm ²	I mm ⁴	S mm ³	r mm	A_f mm ²		
475mm X 225mm	ARX-DW475221016	5.24×10^8	2.21×10^6	180.6	8900	6.07×10^7	5.40×10^5	61.5	7200	16060	28.9
610mm X 203mm	ARX-DW6102030810	9.86×10^8	3.23×10^6	226.5	9178	5.26×10^7	5.18×10^5	52.3	7315	19216	35.6
914mm X 254mm	ARX-DW9142540916	2.87×10^9	3.26×10^7	326.5	15001	1.41×10^8	1.11×10^6	72.5	8128	26908	49.7

Sectional Properties - Unequal Leg Angle

The section values shown on this page have been calculated from the nominal dimensions of the profile. All the shapes listed in the table are available but not all are stocked. For information on availability and price, contact Treadwell Group on 1800 246 800.

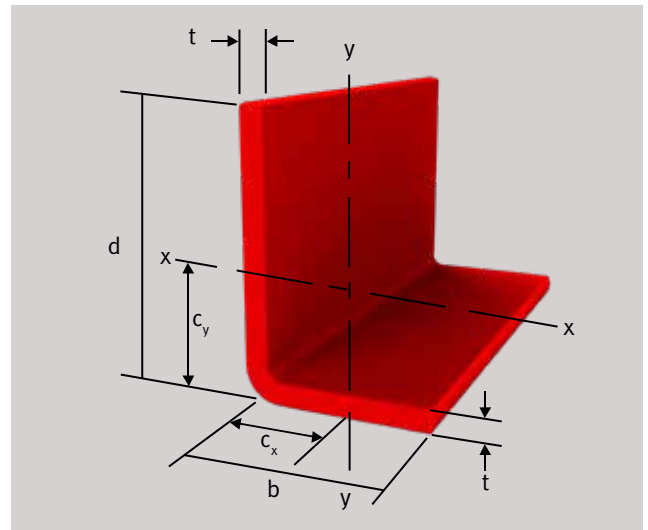

Unequal Leg Angle		Section Dimensions							Section Properties					
Part	Part Number								x-x			y-y		
		d mm	b mm	t mm	C _x mm	C _y mm	Area mm ²	Weight Kg./m	I mm ⁴	S mm ³	r mm	I mm ⁴	S mm ³	r mm
152.4 x 101.6 x 12.7mm	ARX-UL15210213	152.4	101.6	12.7	25.5	51.4	2981	5.4	6995262	69287	48.4	2532460	33256	29.1

Sectional Properties

Sectional Properties - Equal Leg Angle

The section values shown on this page have been calculated from the nominal dimensions of the profile. All the shapes listed in the table are available but not all are stocked. For information on availability and price, contact Treadwell Group on 1800 246 800.

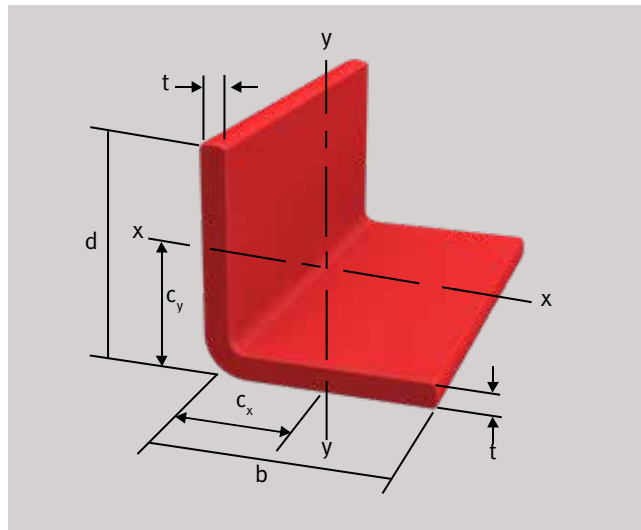

Equal Leg Angle		Section Dimensions						Section Properties		
Part	Part Number	d mm	b mm	t mm	C _x /C _y mm	Area mm ²	Weight Kg./m	I mm ⁴	S mm ³	r mm
25.4 x 3.2mm	ARX-EL02503	25.4	25.4	3.2	7.5	151.2	0.27	9042	506	7.7
31.8 x 3.2mm	ARX-EL03203	31.8	31.8	3.2	9.1	191.5	0.35	18292	808	9.8
38.1 x 4.8mm	ARX-EL03805	38.1	38.1	4.8	11.3	339.3	0.61	45676	1702	11.6
38.1 x 6.4mm	ARX-EL03806	38.1	38.1	6.4	11.8	443.4	0.80	57658	2195	11.4
50.8 x 6.4mm	ARX-EL05106	50.8	50.8	6.4	15.0	604.7	1.09	144678	4045	15.5
76.2 x 6.4mm	ARX-EL07606	76.2	76.2	6.4	21.4	927.2	1.67	517892	9450	23.6
76.2 x 9.5mm	ARX-EL07610	76.2	76.2	9.5	22.5	1360.6	2.45	732434	13650	23.2
76.2 x 12.7mm	ARX-EL07613	76.2	76.2	12.7	23.7	1773.8	3.20	922528	17561	22.8
101.6 x 6.4mm	ARX-EL10206	101.6	101.6	6.4	27.8	1249.7	2.25	1265063	17131	31.8
101.6 x 9.5mm	ARX-EL10210	101.6	101.6	9.5	28.9	1844.3	3.32	1814196	24959	31.4
101.6 x 12.7mm	ARX-EL10213	101.6	101.6	12.7	30.1	2418.8	4.36	2314854	32356	30.9
152.4 x 9.5mm	ARX-EL15210	152.4	152.4	9.5	41.6	2811.8	5.07	6404379	57819	47.7
152.4 x 12.7mm	ARX-EL15213	152.4	152.4	12.7	42.8	3709.7	6.69	8286266	75600	47.3

Sectional Properties – Rectangular Hollow Section

The section values shown on this page have been calculated from the nominal dimensions of the profile. All the shapes listed in the table are available but not all are stocked. For information on availability and price, contact Treadwell Group on 1800 246 800.

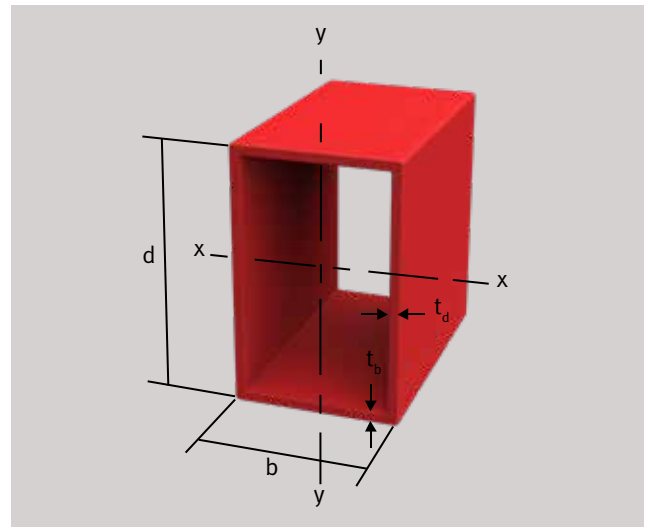

Rectangular Hollow Section		Section Dimensions			
Part	Part Number	d mm	b mm	t _d mm	t _b mm
38.1 x 19.1 x 3.2mm	ARX-RH03801903	38.1	19.1	3.2	3.2
38.1 x 25.4 x 3.2mm	ARX-RH03802503	38.1	25.4	3.2	3.2
50.8 x 25.4 x 3.2mm	ARX-RH05102503	50.8	25.4	3.2	3.2
100 x 75 x 5.5	ARX-RH10007505	100	75	5.5	5.5
101.6 x 25.4 x 3.2mm	ARX-RH10202503	101.6	25.4	3.2	3.2
101.6 x 3.2 x 50.8 x 6.4mm	ARX-RH10205106	101.6	50.8	3.2	6.4
111.1 x 3.2 x 34.9 x 4.8mm	ARX-RH11103505	111.13	34.93	3.2	4.8
139.7 x 88.9 x 6.4mm	ARX-RH14008906	139.7	88.9	6.4	6.4
152.4 x 101.6 x 6.4mm	ARX-RH15210206	152.4	101.6	6.4	6.4

Sectional Properties

Rectangular Hollow Section		Section Properties										
Part	Part Number	x-x				y-y						
		I mm ⁴	S mm ³	r mm	A _w mm ²	I mm ⁴	S mm ³	r mm	J mm ⁴	A _w mm ²	Area mm ²	Weight Kg./m
38.1 x 19.1 x 3.2mm	ARX-RH03801903	53926	2831	12.9	80.7	16530	1735	7.2	38425	202.9	322.5	0.6
38.1 x 25.4 x 3.2mm	ARX-RH03802503	66256	3478	13.5	121.0	33738	2657	9.6	66944	202.9	362.8	0.7
50.8 x 25.4 x 3.2mm	ARX-RH05102503	138066	5436	16.0	121.0	43994	3464	9.9	104510	284.2	443.4	0.8
100 x 75 x 6.4	ARX-H10007506	2854389	57088	36.9	558.1	1786067	47628	29.2	4640456	439.0	2102.5	3.9
101.6 x 25.4 x 3.2mm	ARX-RH10202503	848044	16694	33.3	121.0	83870	6604	10.5	251849	609.3	765.9	1.4
101.6 x 3.2 x 50.8 x 6.4mm	ARX-RH10205106	1837272	36167	39.0	564.5	459318	18083	19.5	1097485	609.3	1209.4	2.2
111.1 x 3.2 x 34.9 x 4.8mm	ARX-RH11103505	1496450	26933	39.1	272.2	196946	11278	14.2	567844	670.3	977.6	1.8
139.7 x 88.9 x 6.4mm	ARX-RH14008906	7190831	102947	51.2	967.7	3496778	78668	35.7	7128059	1624.3	2741.3	4.9
152.4 x 101.6 x 6.4mm	ARX-RH15210206	9770599	128223	56.5	1129.0	5140025	101182	41.0	10185433	1786.9	3063.8	5.5

Sectional Properties - Circular Hollow Section

The section values shown on this page have been calculated from the nominal dimensions of the profile. All the shapes listed in the table are available but not all are stocked. For information on availability and price, contact Treadwell Group on 1800 246 800.

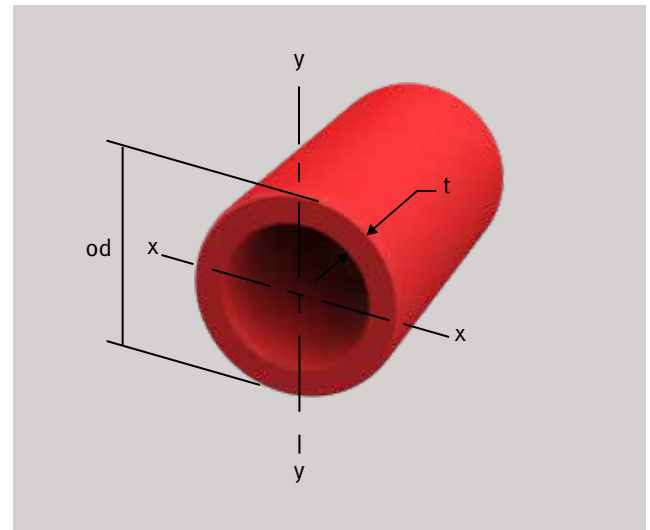

Circular Hollow Section		Section Dimensions				Section Properties		
Part	Part Number	od mm	t mm	Area mm ²	Weight Kg./m	I mm ⁴	S mm ³	r mm
		Diameter	Wall					
25.4 x 2.4mm	ARX-CH02502	25.4	2.4	174.2	0.31	11586	912	8.1
25.4 x 3.2mm	ARX-CH02503	25.4	3.2	219.4	0.39	14027	1105	7.9
28.6 x 3.2mm	ARX-CH02903	28.6	3.2	251.6	0.45	20812	1475	9.1
31.8 X 2.4mm	ARX-CH03202	31.8	2.4	219.4	0.39	24974	1516	10.4
31.8 x 3.2mm	ARX-CH03203	31.8	3.2	283.9	0.51	29136	1803	10.2
31.8 x 6.4mm	ARX-CH03206	31.8	6.4	509.7	0.91	41623	2786	9.1
38.1 x 3.2mm	ARX-CH03803	38.1	3.2	348.4	0.62	54110	2826	12.4
38.1 x 6.4mm	ARX-CH03806	38.1	6.4	632.3	1.13	83246	4425	11.4
44.5 x 3.2mm	ARX-CH04503	44.5	3.2	412.9	0.74	87409	3933	14.7
44.5 x 6.4mm	ARX-CH04506	44.5	6.4	761.3	1.36	141519	6391	13.7
47.6 x 4.8mm	ARX-CH04805	47.6	4.8	638.7	1.14	149843	6227	15.2
50.8 x 6.4mm	ARX-CH05106	50.8	6.4	883.9	1.58	224765	8849	15.7
76.2 x 6.4mm	ARX-CH07606	76.2	6.4	1393.5	2.49	857437	22450	24.9
76.2 x 12.7mm	ARX-CH07613	76.2	12.7	2535.5	4.54	1327778	34904	22.9

Sectional Properties

Section Properties - Solid Bar

The section values shown on this page have been calculated from the nominal dimensions of the profile. All the shapes listed in the table are available but not all are stocked. For information on availability and price, contact Treadwell Group on 1800 246 800.

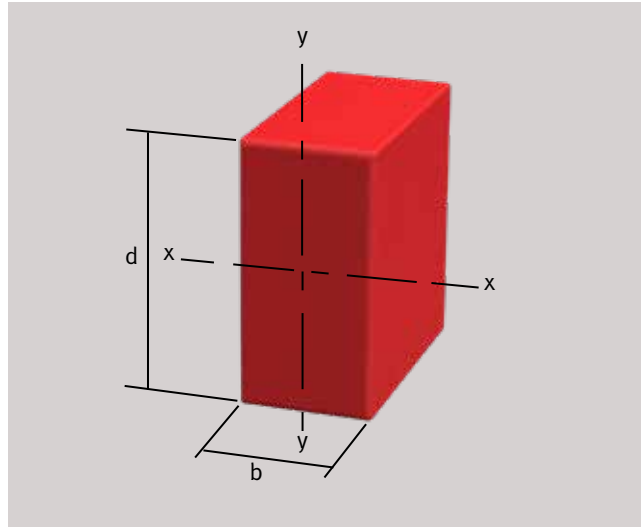

Solid Bars		Section Dimensions				Section Properties					
Part	Part Number	d mm	b mm	Area mm ²	Weight Kg./m	x-x			y-y		
						I mm ⁴	S mm ³	r mm	I mm ⁴	S mm ³	r mm
Square Bar											
25.4mm	ARX-SB25	25.4	25.4	645.2	1.2	33299	2786	7.4	33299	2786	7.4
31.8mm	ARX-SB32	31.8	31.8	1006.4	1.8	83246	5408	9.1	83246	5408	9.1
38.1mm	ARX-SB38	38.1	38.1	1451.6	2.6	174817	9177	10.9	174817	9177	10.9
Rectangular Bar											
38.1 x 19.1mm	ARX-RB3819	38.1	19.1	725.8	1.3	87798.82	4608.86	11.0	21949.70	2304.43	5.5
38.1 x 25.4mm	ARX-RB3825	38.10	25.4	967.7	1.7	117065.09	6145.15	11.0	52028.93	4096.77	7.3
50.8 x 12.7mm	ARX-RB5113	50.8	12.7	645.2	1.2	138743.81	5462.35	14.7	8671.49	1365.59	3.7

Sectional Properties - Circular Round Bar

The section values shown on this page have been calculated from the nominal dimensions of the profile. All the shapes listed in the table are available but not all are stocked. For information on availability and price, contact Treadwell Group on 1800 246 800.

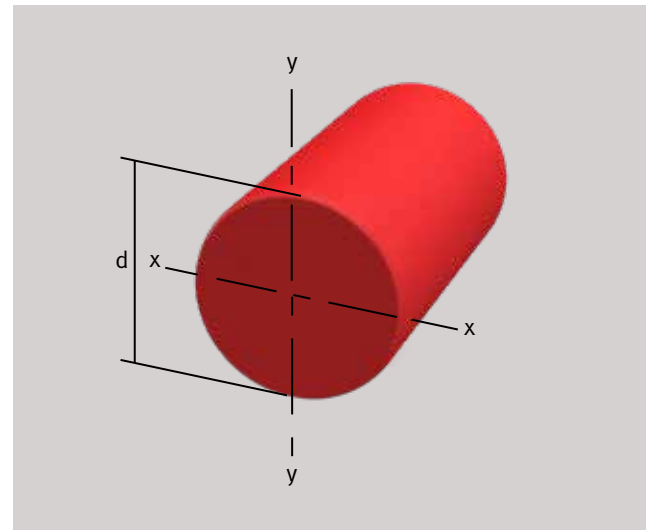

Circular Round Bar		Section Dimensions			Section Properties		
Part	Part Number	d mm	Area mm ²	Weight Kg./m	I mm ⁴	S mm ³	r mm
6.4mm	ARX-CB06	6.4	31.6	0.06	83	26	1.6
7.6mm	ARX-CB07	7.6	45.8	0.08	166	44	1.9
7.9mm	ARX-CB08	7.9	49.7	0.09	191	49	2.0
8.9mm	ARX-CB09	8.9	61.9	0.11	308	69	2.2
9.5mm	ARX-CB10	9.5	71.0	0.13	400	85	2.4
11.1mm	ARX-CB11	11.1	96.8	0.17	749	134	2.8
12mm	ARX-CB12A	12.0	112.9	0.20	999	169	3.0
12.2mm	ARX-CB12	12.2	116.8	0.21	1082	179	3.0
12.7mm	ARX-CB13	12.7	126.5	0.23	1290	202	3.2
15.9mm	ARX-CB16	15.9	198.1	0.36	3122	393	4.0
19.1mm	ARX-CB19	19.1	285.2	0.51	6493	678	4.8
20.6mm	ARX-CB21	20.6	334.2	0.60	8907	864	5.2
22.2mm	ARX-CB22	22.2	387.7	0.69	11987	1078	5.6
25.4mm	ARX-CB25	25.4	506.5	0.91	20437	1609	6.4
31.8mm	ARX-CB32	31.8	791.6	1.42	49865	3141	7.9
38.1mm	ARX-CB38	38.1	1139.4	2.04	103434	5429	9.5

Sectional Properties

Section Properties - Embedment Angle

The section values shown on this page have been calculated from the nominal dimensions of the profile. All the shapes listed in the table are available but not all are stocked. For information on availability and price, contact Treadwell Group on 1800 246 800.

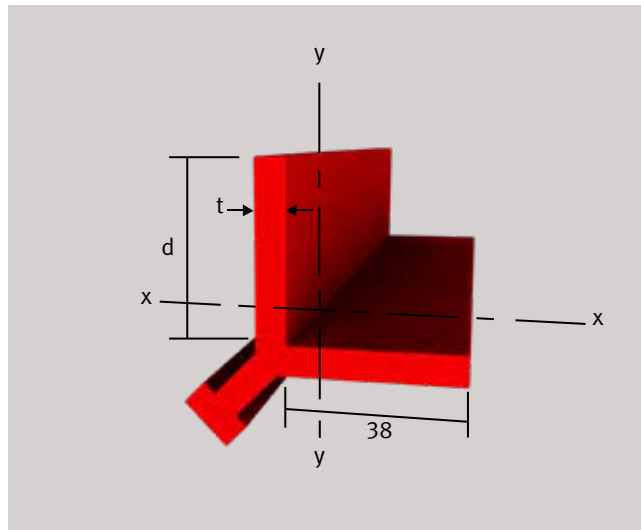

Embedment Angle		Section Dimensions				Section Properties					
Part	Part Number	d mm	t mm	Area mm ²	Weight Kg./m	x-x			y-y		
						I mm ⁴	S mm ³	r mm	I mm ⁴	S mm ³	r mm
25.4 X 38.1mm	ARX-EA25	25.4	6.4	696.8	1.43	116544	4916	12.9	212278	5407	17.5
38.1 X 38.1mm	ARX-EA38	38.1	6.4	774.2	1.64	212278	5407	16.5	212278	5407	16.5
50.8 X 38.1mm	ARX-EA51	50.8	6.4	858.1	1.68	366283	8849	20.6	212278	5407	15.7

Sectional Properties - Square Hollow Section

The section values shown on this page have been calculated from the nominal dimensions of the profile. All the shapes listed in the table are available but not all are stocked. For information on availability and price, contact Treadwell Group on 1800 246 800.

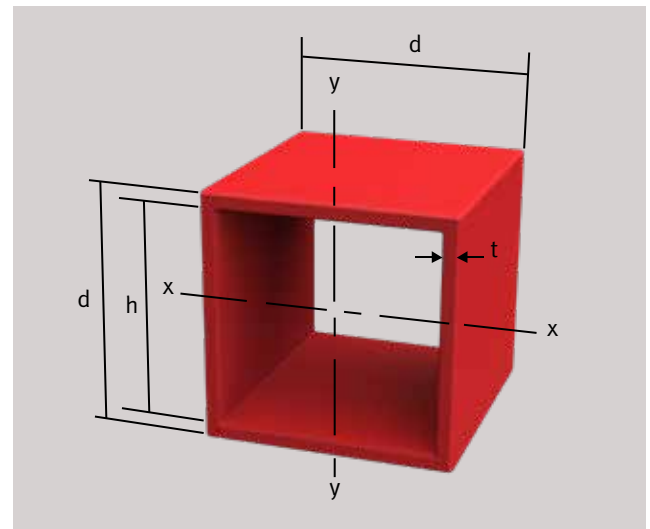

Part	Part Number	d mm	t mm	h mm
25.4 x 3.2mm	ARX-SH02503	25.4	3.2	19.1
25.4 x 6.4mm	ARX-SH02506	25.4	6.4	12.7
31.8 x 3.2mm	ARX-SH03203	31.8	3.2	25.4
31.8 x 6.4mm	ARX-SH03206	31.8	6.4	19.1
38.1 x 3.2mm	ARX-SH03803	38.1	3.2	31.8
38.1 x 6.4mm	ARX-SH03806	38.1	6.4	25.4
44.5 x 3.2mm	ARX-SH04503	44.5	3.2	38.1
44.5 x 6.4mm	ARX-SH04506	44.5	6.4	31.8
50.8 x 3.2mm	ARX-SH05103	50.8	3.2	44.5
50.8 x 6.4mm	ARX-SH05106	50.8	6.4	38.1
50.8 x 9.5mm	ARX-SH05110	50.8	9.5	31.8
57.2 x 3.2mm	ARX-SH05703	57.2	3.2	50.8
76.2 x 3.2mm	ARX-SH07603	76.2	3.2	69.9
76.2 x 6.4mm	ARX-SH07606	76.2	6.4	63.5
88.9 x 6.4mm	ARX-SH08906	88.9	6.4	76.2
101.6 x 6.4mm	ARX-SH10206	101.6	6.4	89.9
101.6 x 8mm	ARX-SH10208	101.6	8	85.6
101.6 x 9.5mm	ARX-SH10210	101.6	9.5	82.6
127 x 8mm	ARX-SH12708	127	8	111.0
152.4 x 9.5mm	ARX-SH15210	152.4	9.5	133.4

Sectional Properties

Square Hollow Section		Section Properties						
Part	Part Number	I mm ⁴	S mm ³	r mm	J mm ⁴	A _w mm ²	Area mm ²	Weight Kg./m
25.4 x 3.2mm	ARX-SH02503	23711	1867	9.2	36151	120.9	282.2	0.5
25.4 x 6.4mm	ARX-SH02506	32518	2560	8.2	51053	161.3	483.8	0.9
31.8 x 3.2mm	ARX-SH03203	49997	3149	11.7	81777	161.3	362.8	0.7
31.8 x 6.4mm	ARX-SH03206	73708	4643	10.7	124615	241.9	645.0	1.2
38.1 x 3.2mm	ARX-SH03803	90915	4772	14.3	142846	201.6	443.4	0.8
38.1 x 6.4mm	ARX-SH03806	140912	7397	13.2	227439	322.5	806.3	1.5
44.5 x 3.2mm	ARX-SH04503	149719	6736	16.9	245581	241.9	524.1	0.9
44.5 x 6.4mm	ARX-SH04506	240634	10827	15.8	405671	403.1	967.5	1.7
50.8 x 3.2mm	ARX-SH05103	229659	9042	19.5	365396	282.2	604.7	1.1
50.8 x 6.4mm	ARX-SH05106	379377	14936	18.3	618023	483.8	1128.8	2.0
50.8 x 9.5mm	ARX-SH05110	470292	18515	17.3	781349	604.7	1572.2	2.8
57.2 x 3.2mm	ARX-SH05703	333987	11688	22.1	518919	322.5	685.3	1.2
76.2 x 3.2mm	ARX-SH07603	825823	21675	29.8	1270000	443.4	927.2	1.7
76.2 x 6.4mm	ARX-SH07606	1454641	38179	28.6	2290000	806.3	1773.8	3.2
88.9 x 6.4mm	ARX-SH08906	2395496	53892	33.8	3790000	967.5	2096.3	3.8
101.6 x 6.4mm	ARX-SH10206	3674539	72333	39.0	5850000	1128.8	2418.8	4.4
101.6 x 8mm	ARX-SH10208	4405420	86721	38.4	7010000	1369.6	2995.2	5.4
101.6 x 9.5mm	ARX-SH10210	5009812	98618	37.8	8010000	1572.2	3507.2	6.3
127 x 8mm	ARX-SH12708	9028133	142175	48.7	14100000	1776.0	3808.0	6.9
152.4 x 9.5mm	ARX-SH15210	18602355	244125	58.5	28700000	2539.7	5442.2	9.8

Sectional Properties - Flat Sheet

The section values shown on this page have been calculated from the nominal dimensions of the profile. All the shapes listed in the table are available but not all are stocked. For information on availability and price, contact Treadwell Group on 1800 246 800.

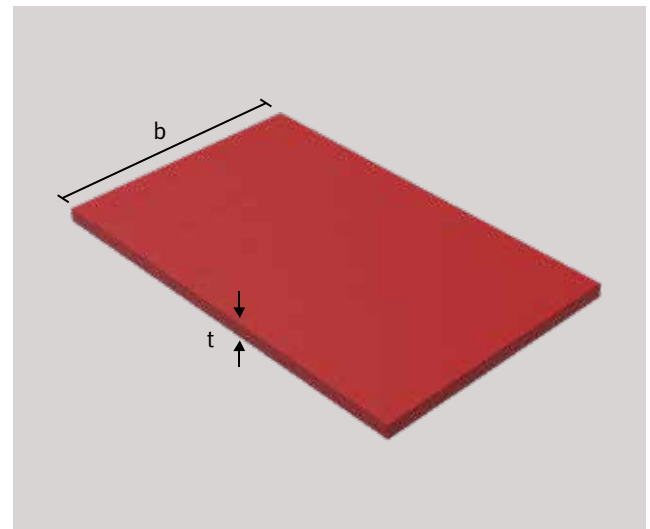

Flat Sheet		Section Dimensions	Section Properties
Part	Part Number	t mm	Weight kg./m ²
3.2mm	ARX-FP03	3.2	6.1
6.4mm	ARX-FP06	6.4	12.2
9.5mm	ARX-FP10	9.5	18
12.7mm	ARX-FP13	12.7	24.1
15.9mm	ARX-FP16	15.9	30.2
19.1mm	ARX-FP19	19.1	36.1
25.4mm	ARX-FP25	25.4	48.3

Note: Standard sheet width is 1200mm.

Allowable Uniform Load Tables

Full section 3-point bending tests were conducted on Treadwell Reinforced Plastics' H-Beams, I-Beams, C Section and Square Hollow Section. The allowable uniform load tables were generated using these tests results as well as the formulas, properties, and assumptions listed below. Formulas for critical buckling and lateral-torsional buckling developed from theory are presented in Chapter 6 and 7 of the ASCE Structural Plastics Design Manual.

Beams - Allowable Uniforms Loads

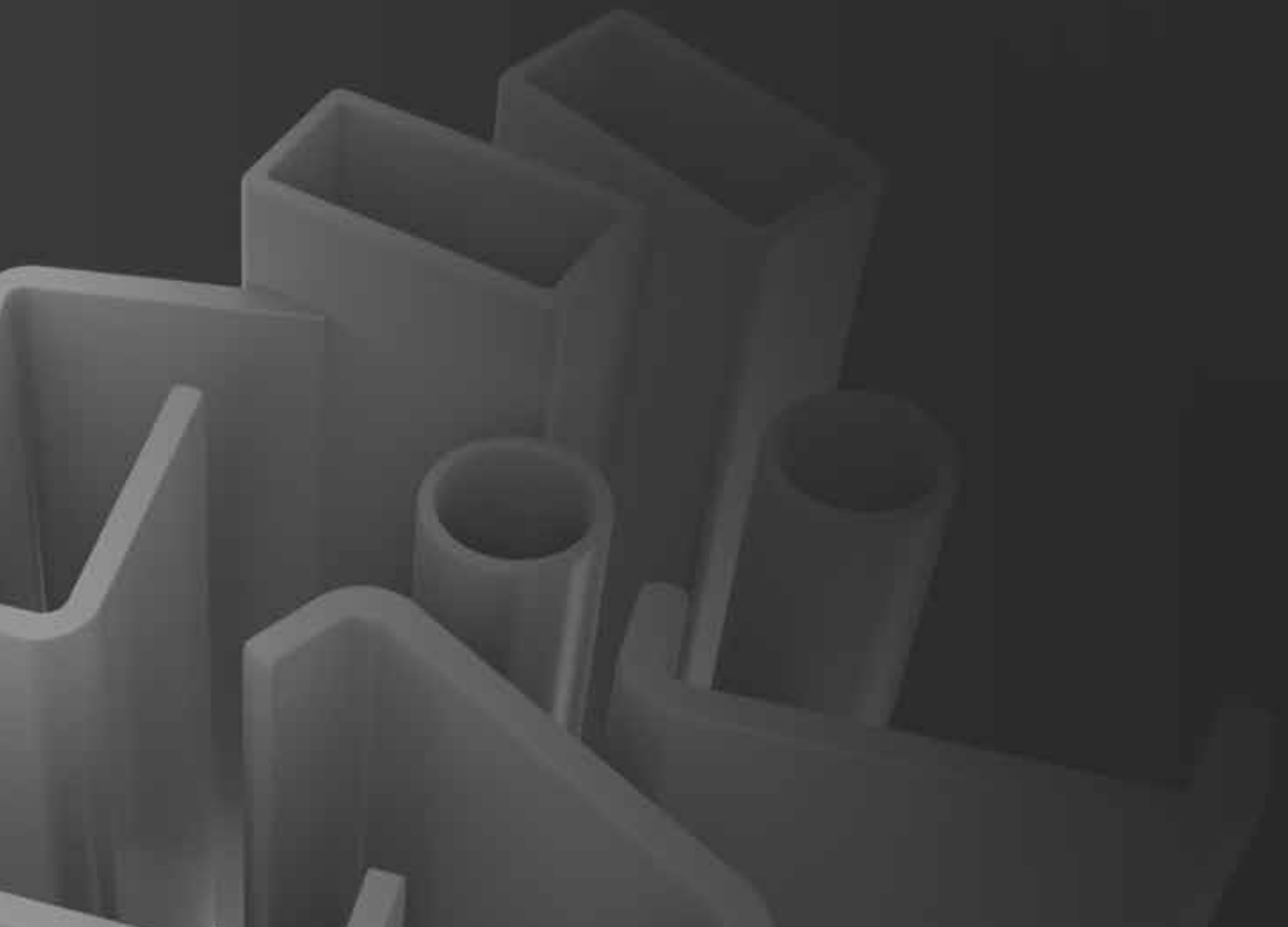

Notation	
A_w	area of web (mm. ²)
b	flange width (mm.)
b_c	C Section flange minus thickness (mm.)
b_h	1/2 of flange width (mm.)
d	depth of section (mm.)
E	modulus of elasticity (GPa)
f_b	actual flexural stress (MPa)
F_b	maximum allowable flexural stress (MPa)
F_{aCB}	maximum allowable buckling stress (MPa)
F_{aLTB}	maximum allowable lateral-torsional buckling stress (MPa)
f_v	actual shear stress (MPa)
F_v	maximum allowable shear stress (MPa)
G	shear modulus (GPa)
I	moment of inertia (mm. ⁴)
J	torsion constant (mm. ⁴)
L	length of span (mm.)
M	maximum moment (N.-m.)
S_x	section modulus (mm ³)
t	flange thickness (mm.)
V	vertical shear force (N.)
w	uniform load (N/m.)
ν_t	poission's ratio (longitudinal)
ν_r	poission's ratio (transverse)
Δ	midspan deflection (mm.)

Assumptions

- Beam simply supported at both ends
- Uniformly distributed load
- Load is applied perpendicular to major axis
- Part weight has been deducted in tables
- Safety factor of 3.0 for both ultimate material flexural and shear stress and 2.5 for buckling stresses
- Higher safety factors may be required for permanent loading, impact loading or high temperature consideration.

Beams - Allowable Uniform Loads

Properties / Allowables	Formulas
E= 20.7 GPa	$\Delta = \frac{5wL^4}{384EI} + \frac{wL^2}{8A_w G}$
G = 3.1 GPa	
F _b = 68.9 MPa (F.O.S. = 3)	$f_b = \frac{M}{S_x}$
F _v = 10.3 MPa (F.O.S. = 3)	$f_v = \frac{V}{A_w}$

Note: Enough orthogonal bracing shall be considered to prevent the lateral torsional buckling.

C Section

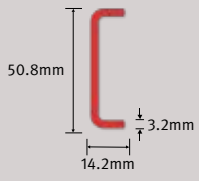

Beams - Allowable Uniform Loads

Part: 50.8 x 14.2 x 3.2mm							
Part Number: ARX-CS0511403							
			A_w	142.1mm ²	Wt.	0.4kg/m	
			I	7.48 x 10 ⁴ mm ⁴	S	2943mm ³	
Span (m)	Maximum Load (kN/m)		Deflection (kN/m)				
			L/100	L/150	L/180	L/240	L/360
0.5	5.85	F_v	--	4.79	3.99	2.99	1.99
0.8	2.53	F_b	1.87	1.25	1.04	0.78	0.52
1.1	1.34	F_b	0.73	0.49	0.41	0.31	0.20
1.4	0.83	F_b	0.36	0.24	0.20	0.15	0.10
1.7	0.56	F_b	0.20	0.13	0.11	0.08	0.06
2.0	0.41	F_b	0.12	0.08	0.07	0.05	0.03
2.3	0.31	F_b	0.08	0.05	0.05	0.03	0.02
2.6	0.24	F_b	0.06	0.04	0.03	0.02	0.02
The part weight has been deducted in the above table.							

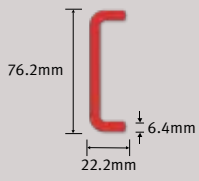
Part: 76.2 x 22.2 x 6.4mm							
Part Number: ARX-CS0762206							
			A_w	405.8mm ²	Wt.	1.2kg/m	
			I	4.81 x 10 ⁵ mm ⁴	S	12617mm ³	
Span (m)	Maximum Load (kN/m)		Deflection (kN/m)				
			L/100	L/150	L/180	L/240	L/360
0.8	10.45	F_v	--	7.61	6.34	4.75	3.17
1.1	5.75	F_b	4.58	3.06	2.55	1.91	1.27
1.4	3.55	F_b	2.27	1.51	1.26	0.94	0.63
1.7	2.41	F_b	1.28	0.85	0.71	0.53	0.36
2.0	1.74	F_b	0.79	0.53	0.44	0.33	0.22
2.3	1.31	F_b	0.52	0.35	0.29	0.22	0.14
2.6	1.03	F_b	0.36	0.24	0.20	0.15	0.10
2.9	0.83	F_b	0.26	0.17	0.15	0.11	0.07
The part weight has been deducted in the above table.							

Beams - Allowable Uniform Loads

Part: 76.2 x 25.4 x 6.4mm							
Part Number: ARX-CS0762506							
			A_w	405.8mm ²	Wt.	1.3kg/m	
			I	5.30 x 10 ⁵ mm ⁴	S	13912mm ³	
Span (m)	Maximum Load (kN/m)		Deflection (kN/m)				
			L/100	L/150	L/180	L/240	L/360
0.8	10.45	F _v	--	8.31	6.92	5.19	3.46
1.1	6.34	F _b	5.03	3.35	2.79	2.10	1.40
1.4	3.91	F _b	2.49	1.66	1.38	1.04	0.69
1.7	2.65	F _b	1.41	0.94	0.78	0.59	0.39
2.0	1.92	F _b	0.87	0.58	0.48	0.36	0.24
2.3	1.45	F _b	0.57	0.38	0.32	0.24	0.16
2.6	1.13	F _b	0.40	0.27	0.22	0.17	0.11
2.9	0.91	F _b	0.29	0.19	0.16	0.12	0.08
The part weight has been deducted in the above table.							

Part: 76.2 x 38.1 x 6.4mm							
Part Number: ARX-CS0763806							
			A_w	405.8mm ²	Wt.	1.6kg/m	
			I	7.27 x 10 ⁵ mm ⁴	S	19090mm ³	
Span (m)	Maximum Load (kN/m)		Deflection (kN/m)				
			L/100	L/150	L/180	L/240	L/360
0.8	10.45	F _v	--	--	9.16	6.87	4.58
1.1	7.60	F _v	6.76	4.51	3.76	2.82	1.88
1.4	5.37	F _b	3.38	2.25	1.88	1.41	0.94
1.7	3.64	F _b	1.91	1.28	1.06	0.80	0.53
2.0	2.63	F _b	1.19	0.79	0.66	0.49	0.33
2.3	1.99	F _b	0.78	0.52	0.44	0.33	0.22
2.6	1.56	F _b	0.55	0.36	0.30	0.23	0.15
2.9	1.25	F _b	0.39	0.26	0.22	0.16	0.11
The part weight has been deducted in the above table.							

Beams - Allowable Uniform Loads

Part: 88.9 x 3.2 x 30.2 x 4.8mm							
Part Number: ARX-CS0893005							
			A_w	253.8mm ²	Wt.	1.0kg/m	
			I	6.41 x 10 ⁵ mm ⁴	S	14428mm ³	
Span (m)	Maximum Load (kN/m)		Deflection (kN/m)				
			L/100	L/150	L/180	L/240	L/360
0.8	6.53	F _v	--	--	--	5.75	3.83
1.1	4.75	F _v	--	3.86	3.22	2.41	1.61
1.4	3.73	F _v	2.92	1.95	1.62	1.22	0.81
1.7	2.75	F _b	1.67	1.11	0.93	0.69	0.46
2.0	1.99	F _b	1.04	0.69	0.58	0.43	0.29
2.3	1.50	F _b	0.69	0.46	0.38	0.29	0.19
2.6	1.18	F _b	0.48	0.32	0.27	0.20	0.13
2.9	0.95	F _b	0.35	0.23	0.19	0.14	0.10
3.2	0.78	F _b	0.26	0.17	0.14	0.11	0.07
3.5	0.65	F _b	0.20	0.13	0.11	0.08	0.05
The part weight has been deducted in the above table.							

Part: 88.9 x 38.1 x 4.8mm							
Part Number: ARX-CS0893805							
			A_w	380.6mm ²	Wt.	1.3kg/m	
			I	841417mm ⁴	S	18930mm ³	
Span (m)	Maximum Load (kN/m)		Deflection (kN/m)				
			L/100	L/150	L/180	L/240	L/360
0.8	9.8	F _v	--	--	--	7.71	5.14
1.1	7.13	F _v	--	5.13	4.27	3.20	2.14
1.4	5.32	F _b	3.86	2.58	2.15	1.61	1.07
1.7	3.61	F _b	2.20	1.47	1.22	0.92	0.61
2.0	2.61	F _b	1.36	0.91	0.76	0.57	0.38
2.3	1.97	F _b	0.90	0.60	0.50	0.38	0.25
2.6	1.54	F _b	0.63	0.42	0.35	0.26	0.17
2.9	1.24	F _b	0.45	0.30	0.25	0.19	0.13
3.2	1.02	F _b	0.34	0.23	0.19	0.14	0.09
3.5	0.85	F _b	0.26	0.17	0.14	0.11	0.07
The part weight has been deducted in the above table.							

Beams - Allowable Uniform Loads

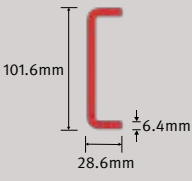
Part: 101.6 x 28.6 x 6.4mm							
Part Number: ARX-CS1022906							
			A_w	568.3mm ²	Wt.	1.7kg/m	
			I	1.20 x 10 ⁶ mm ⁴	S	23546mm ³	
Span (m)	Maximum Load (kN/m)		Deflection (kN/m)				
			L/100	L/150	L/180	L/240	L/360
0.8	14.63	F_v	--	--	--	11.05	7.37
1.1	10.64	F_v	--	7.32	6.10	4.57	3.05
1.4	6.62	F_b	5.51	3.67	3.06	2.29	1.53
1.7	4.49	F_b	3.13	2.09	1.74	1.30	0.87
2.0	3.24	F_b	1.94	1.30	1.08	0.81	0.54
2.3	2.45	F_b	1.29	0.86	0.71	0.54	0.36
2.6	1.92	F_b	0.89	0.60	0.50	0.37	0.25
2.9	1.54	F_b	0.65	0.43	0.36	0.27	0.18

The part weight has been deducted in the above table.

Beams - Allowable Uniform Loads

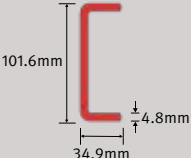
Part: 101.6 x 34.9 x 4.8mm							
Part Number: ARX-CS1023505							
			A_w	441.6mm ²	Wt.	1.4kg/m	
			I	1.09 x 10 ⁶ mm ⁴	S	21462mm ³	
Span (m)	Maximum Load (kN/m)		Deflection (kN/m)				
			L/100	L/150	L/180	L/240	L/360
0.8	11.37	F_v	--	--	9.54	7.15	4.77
1.1	8.27	F_v	--	6.57	5.48	4.11	2.74
1.4	6.04	F_b	4.97	3.31	2.76	2.07	1.38
1.7	4.09	F_b	2.84	1.89	1.58	1.18	0.79
2.0	2.96	F_b	1.76	1.18	0.98	0.73	0.49
2.3	2.24	F_b	1.17	0.78	0.65	0.49	0.32
2.6	1.75	F_b	0.81	0.54	0.45	0.34	0.23
2.9	1.41	F_b	0.59	0.39	0.33	0.25	0.16

The part weight has been deducted in the above table.

Beams - Allowable Uniform Loads

Part: 139.7 x 38.1 x 6.4mm							
Part Number: ARX-CS1403806							
			A_w	812.2mm ²	Wt.	2.3kg/m	
			I	3.24 x 10 ⁶ mm ⁴	S	46337mm ³	
Major Axis (kN/m)							
Span (m)	Maximum Load (kN/m)		Deflection (kN/m)				
			L/100	L/100	L/180	L/240	L/360
0.8	20.91	F _v	--	--	--	--	17.57
1.1	15.21	F _v	--	--	--	11.50	7.67
1.4	11.95	F _v	--	9.47	7.89	5.92	3.95
1.7	8.84	F _b	8.19	5.46	4.55	3.41	2.28
2.0	6.39	F _b	5.13	3.42	2.85	2.14	1.43
2.3	4.83	F _b	3.42	2.28	1.90	1.42	0.95
2.6	3.78	F _b	2.39	1.59	1.33	0.99	0.66
2.9	3.04	F _b	1.73	1.15	0.96	0.72	0.48
3.2	2.49	F _b	1.29	0.86	0.72	0.54	0.36
3.5	2.08	F _b	0.99	0.66	0.55	0.41	0.28
3.8	1.77	F _b	0.78	0.52	0.43	0.32	0.22
4.1	1.52	F _b	0.62	0.41	0.34	0.26	0.17
4.4	1.32	F _b	0.50	0.33	0.28	0.21	0.14
Minor Axis (N/m)							
A_w	361.2mm ²			Wt.	2.22 kg/m		
I	133194mm ⁴			S	4752mm ³		
Span (m)	Maximum Load (N/m)		Deflection (N/m)				
			L/100	L/150	L/180	L/240	L/360
0.91	3073	F _b	2425	1607	1334	993	652
1.22	1716	F _b	1029	676	559	412	265
1.52	1088	F _b	518	336	275	199	123
1.83	746	F _b	289	183	148	104	59
The part weight has been deducted in the above table.							

Beams - Allowable Uniform Loads

Part: 152.4 x 41.3 x 6.4mm							
Part Number: ARX-CS1524106							
			A_w	893.4mm ²	Wt.	2.5kg/m	
			I	4.24 x 10 ⁶ mm ⁴	S	55640mm ³	
Span (m)	Maximum Load (kN/m)		Deflection (kN/m)				
			L/100	L/150	L/180	L/240	L/360
1.5	12.27	F_v	--	10.05	8.37	6.28	4.19
1.8	9.47	F_v	9.00	6.00	5.00	3.75	2.50
2.1	6.95	F_v	5.78	3.86	3.21	2.41	1.61
2.4	5.32	F_b	3.92	2.62	2.18	1.64	1.09
2.7	4.21	F_b	2.78	1.85	1.54	1.16	0.77
3.0	3.41	F_b	2.04	1.36	1.13	0.85	0.57
3.3	2.82	F_b	1.54	1.03	0.86	0.64	0.43
3.6	2.37	F_b	1.10	0.73	0.61	0.46	0.31
3.9	2.02	F_b	0.94	0.63	0.52	0.39	0.26
4.2	1.74	F_b	0.75	0.50	0.42	0.31	0.21
4.5	1.51	F_b	0.61	0.41	0.34	0.26	0.17
The part weight has been deducted in the above table.							

Part: 152.4 x 42.9 x 9.5mm							
Part Number: ARX-CS1524310							
			A_w	1267.3mm ²	Wt.	3.8kg/m	
			I	6.06 x 10 ⁶ mm ⁴	S	79467mm ³	
Span (m)	Maximum Load (kN/m)		Deflection (kN/m)				
			L/100	L/150	L/180	L/240	L/360
1.5	17.40	F_v	--	14.34	11.95	8.96	5.98
1.8	13.52	F_b	12.85	8.57	7.14	5.36	3.57
2.1	9.93	F_b	8.26	5.50	4.59	3.44	2.29
2.4	7.60	F_b	5.60	3.74	3.11	2.33	1.56
2.7	6.01	F_b	3.97	2.65	2.21	1.65	1.10
3.0	4.87	F_b	2.91	1.94	1.62	1.21	0.81
3.3	4.02	F_b	2.20	1.47	1.22	0.92	0.61
3.6	3.38	F_b	1.70	1.13	0.94	0.71	0.47
3.9	2.88	F_b	1.34	0.89	0.75	0.56	0.37
4.2	2.48	F_b	1.08	0.72	0.60	0.45	0.30
4.5	2.16	F_b	0.88	0.58	0.49	0.37	0.24
The part weight has been deducted in the above table.							

Beams - Allowable Uniform Loads

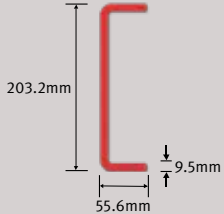
Part: 203.2 x 55.6 x 9.5mm							
Part Number: ARX-CS2035610							
			A_w	1749.9mm ²	Wt.	5.1kg/m	
			I	1.49 x 10 ⁷ mm ⁴	S	146560mm ³	
Span (m)	Maximum Load (kN/m)		Deflection (kN/m)				
			L/100	L/150	L/180	L/240	L/360
1.5	24.03	F _v	--	--	--	20.41	13.60
1.8	20.03	F _v	--	19.93	16.61	12.45	8.30
2.1	17.17	F _v	--	12.98	10.81	8.11	5.41
2.4	14.02	F _b	13.33	8.89	7.41	5.56	3.70
2.7	11.08	F _b	9.51	6.34	5.28	3.96	2.64
3.0	8.98	F _b	7.01	4.68	3.90	2.92	1.95
3.3	7.42	F _b	5.31	3.54	2.95	2.21	1.48
3.6	6.23	F _b	4.12	2.75	2.29	1.72	1.14
3.9	5.31	F _b	3.26	2.17	1.81	1.36	0.90
4.2	4.58	F _b	2.62	1.75	1.45	1.09	0.73
4.5	3.99	F _b	2.14	1.42	1.19	0.89	0.59
4.8	3.51	F _b	1.76	1.18	0.98	0.74	0.49
5.1	3.11	F _b	1.47	0.98	0.82	0.61	0.41
5.4	2.77	F _b	1.24	0.83	0.69	0.52	0.35
5.7	2.49	F _b	1.06	0.71	0.59	0.44	0.29
6.0	2.24	F _b	0.91	0.61	0.51	0.38	0.25

The part weight has been deducted in the above table.

Beams - Allowable Uniform Loads

Part: 254 x 69.6 x 12.7mm							
Part Number: ARX-CS2547013							
			A_w	2903.2mm ²	Wt.	8.4kg/m	
			I	3.85 x 10 ⁷ mm ⁴	S	303091mm ³	
Span (m)	Maximum Load (kN/m)		Deflection (kN/m)				
			L/100	L/150	L/180	L/240	L/360
1.8	33.23	F _v	--	--	--	30.11	20.07
2.1	28.48	F _v	--	--	26.56	19.92	13.28
2.4	24.92	F _v	--	22.07	18.39	13.79	9.20
2.7	22.15	F _v	--	15.87	13.22	9.92	6.61
3.0	18.56	F _b	17.65	11.77	9.81	7.35	4.90
3.3	15.34	F _b	13.43	8.95	7.46	5.60	3.73
3.6	12.89	F _b	10.45	6.97	5.81	4.35	2.90
3.9	10.98	F _b	8.28	5.52	4.60	3.45	2.30
4.2	9.47	F _b	6.67	4.45	3.71	2.78	1.85
4.5	8.25	F _b	5.45	3.63	3.03	2.27	1.51
4.8	7.25	F _b	4.51	3.01	2.51	1.88	1.25
5.1	6.42	F _b	3.77	2.52	2.10	1.57	1.05
5.4	5.73	F _b	3.19	2.13	1.77	1.33	0.89
5.7	5.14	F _b	2.72	1.81	1.51	1.13	0.75
6.0	4.64	F _b	2.34	1.56	1.30	0.97	0.65
6.3	4.21	F _b	2.02	1.35	1.12	0.84	0.56
6.6	3.84	F _b	1.76	1.17	0.98	0.73	0.49
6.9	3.51	F _b	1.54	1.03	0.86	0.64	0.43
7.2	3.22	F _b	1.36	0.91	0.76	0.57	0.38
7.5	2.97	F _b	1.20	0.80	0.67	0.50	0.33

The part weight has been deducted in the above table.

Beams - Allowable Uniform Loads

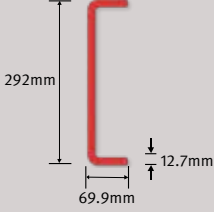
Part: 292 x 69.9 x 12.7mm							
Part Number: ARX-CS2927013							
			A_w	3387.1mm ²	Wt.	9.3kg/m	
			I	5.47×10^7 mm ⁴	S	374704mm ³	
Span (m)	Maximum Load (kN/m)		Deflection (kN/m)				
			L/100	L/150	L/180	L/240	L/360
1.8	38.76	F _v	--	--	--	--	27.45
2.1	33.23	F _v	--	--	--	27.48	18.32
2.4	29.07	F _v	--	--	25.53	19.15	12.77
2.7	25.84	F _v	--	22.13	18.44	13.83	9.22
3.0	22.95	F _b	--	16.46	13.72	10.29	6.86
3.3	18.97	F _b	18.84	12.56	10.47	7.85	5.23
3.6	15.94	F _b	14.69	9.79	8.16	6.12	4.08
3.9	13.58	F _b	11.66	7.77	6.48	4.86	3.24
4.2	11.71	F _b	9.41	6.27	5.23	3.92	2.61
4.5	10.20	F _b	7.69	5.13	4.27	3.21	2.14
4.8	8.96	F _b	6.37	4.25	3.54	2.65	1.77
5.1	7.94	F _b	5.33	3.56	2.96	2.22	1.48
5.4	7.08	F _b	4.51	3.01	2.51	1.88	1.25
5.7	6.36	F _b	3.85	2.56	2.14	1.60	1.07
6.0	5.74	F _b	3.31	2.20	1.84	1.38	0.92
6.3	5.20	F _b	2.86	1.91	1.59	1.19	0.79
6.6	4.74	F _b	2.49	1.66	1.39	1.04	0.69
6.9	4.34	F _b	2.19	1.46	1.21	0.91	0.61
7.2	3.98	F _b	1.93	1.28	1.07	0.80	0.54
7.5	3.67	F _b	1.71	1.14	0.95	0.71	0.47

The part weight has been deducted in the above table.

Beams - Allowable Uniform Loads

Part: 304.8 x 76.2 x 12.7m							
Part Number: ARX-CS3057613							
			A_w	3548.4mm ²	Wt.	9.9kg/m	
			I	6.44 x 10 ⁷ mm ⁴	S	422534mm ³	
Span (m)	Maximum Load (kN/m)		Deflection (kN/m)				
			L/100	L/150	L/180	L/240	L/360
1.8	40.61	F _v	--	--	--	--	31.48
2.1	34.81	F _v	--	--	--	31.69	21.13
2.4	30.46	F _v	--	--	29.56	22.17	14.78
2.7	27.07	F _v	--	25.70	21.42	16.06	10.71
3.0	24.37	F _v	--	19.17	15.97	11.98	7.99
3.3	21.39	F _b	--	14.65	12.21	9.16	6.10
3.6	17.97	F _b	17.15	11.43	9.53	7.15	4.76
3.9	15.31	F _b	13.63	9.09	7.57	5.68	3.79
4.2	13.20	F _b	11.00	7.34	6.11	4.59	3.06
4.5	11.50	F _b	9.01	6.01	5.00	3.75	2.50
4.8	10.11	F _b	7.46	4.98	4.15	3.11	2.07
5.1	8.95	F _b	6.25	4.17	3.47	2.61	1.74
5.4	7.99	F _b	5.29	3.53	2.94	2.20	1.47
5.7	7.17	F _b	4.51	3.01	2.51	1.88	1.25
6.0	6.47	F _b	3.88	2.59	2.15	1.62	1.08
6.3	5.87	F _b	3.36	2.24	1.87	1.40	0.93
6.6	5.35	F _b	2.93	1.95	1.63	1.22	0.81
6.9	4.89	F _b	2.57	1.71	1.43	1.07	0.71
7.2	4.49	F _b	2.26	1.51	1.26	0.94	0.63
7.5	4.14	F _b	2.00	1.34	1.11	0.84	0.56

The part weight has been deducted in the above table.

Beams - Allowable Uniform Loads

Part: 355.6 x 88.9 x 19.1mm							
Part Number: ARX-CS3568919							
			A_w	6062.3mm ²	Wt.	17.0kg/m	
			I	1.47 x 10 ⁸ mm ⁴	S	825770mm ³	
Span (m)	Maximum Load (kN/m)		Deflection (kN/m)				
			L/100	L/150	L/180	L/240	L/360
0.8	156.11	F _v	--	--	--	--	--
1.1	113.53	F _v	--	--	--	--	--
1.4	89.20	F _v	--	--	--	--	--
1.7	73.46	F _v	--	--	--	--	--
2.0	62.44	F _v	--	--	--	--	51.37
2.3	54.30	F _v	--	--	--	53.89	35.93
2.6	48.03	F _v	--	--	--	38.99	25.99
2.9	43.06	F _v	--	--	38.69	29.02	19.34
3.2	39.03	F _v	--	35.41	29.50	22.13	14.75
3.5	35.68	F _v	--	27.57	22.98	17.23	11.49
3.8	31.52	F _b	--	21.86	18.22	13.66	9.11
4.1	27.08	F _b	26.42	17.61	14.68	11.01	7.34
4.4	23.51	F _b	21.58	14.39	11.99	8.99	5.99
4.7	20.60	F _b	17.84	11.90	9.91	7.43	4.96
5.0	18.21	F _b	14.92	9.94	8.29	6.22	4.14
5.3	16.20	F _b	12.59	8.40	7.00	5.25	3.50
5.6	14.51	F _b	10.73	7.15	5.96	4.47	2.98
5.9	13.08	F _b	9.21	6.14	5.12	3.84	2.56
6.2	11.84	F _b	7.96	5.31	4.42	3.32	2.21
6.5	10.77	F _b	6.93	4.62	3.85	2.89	1.93
6.8	9.84	F _b	6.07	4.05	3.37	2.53	1.69
7.1	9.03	F _b	5.34	3.56	2.97	2.23	1.48
7.4	8.31	F _b	4.73	3.15	2.63	1.97	1.31
7.7	7.68	F _b	4.21	2.80	2.34	1.75	1.17

The part weight has been deducted in the above table.

Beams - Allowable Uniform Loads

Part: 457.2 x 60.3 x 9.5mm							
Part Number: ARX-CS4576010							
			A_w	4162.9mm ²	Wt.	9.6kg/m	
			I	1.24 x 10 ⁸ mm ⁴	S	102947mm ³	
Span (m)	Maximum Load (kN/m)		Deflection (kN/m)				
			L/100	L/150	L/180	L/240	L/360
0.8	107.19	F _v	--	--	--	--	--
1.1	77.96	F _v	--	--	--	--	--
1.4	61.25	F _v	--	--	--	--	--
1.7	50.44	F _v	--	--	--	--	--
2.0	42.88	F _v	--	--	--	--	41.06
2.3	37.29	F _v	--	--	--	--	29.02
2.6	32.98	F _v	--	--	--	31.75	21.16
2.9	29.57	F _v	--	--	--	23.77	15.85
3.2	26.80	F _v	--	--	24.29	18.22	12.14
3.5	24.48	F _b	--	22.78	18.98	14.24	9.49
3.8	20.76	F _b	--	18.12	15.10	11.32	7.55
4.1	17.84	F _b	--	14.63	12.19	9.14	6.10
4.4	15.49	F _b	--	11.98	9.98	7.48	4.99
4.7	13.57	F _b	--	9.92	8.27	6.20	4.13
5.0	11.99	F _b	--	8.30	6.92	5.19	3.46
5.3	10.67	F _b	10.53	7.02	5.85	4.39	2.92
5.6	9.56	F _b	8.98	5.98	4.99	3.74	2.49
5.9	8.61	F _b	7.71	5.14	4.28	3.21	2.14
6.2	7.80	F _b	6.67	4.45	3.71	2.78	1.85
6.5	7.10	F _b	5.81	3.88	3.23	2.42	1.61
6.8	6.48	F _b	5.09	3.40	2.83	2.12	1.41
7.1	5.95	F _b	4.49	2.99	2.49	1.87	1.25
7.4	5.48	F _b	3.97	2.65	2.21	1.66	1.10
7.7	5.06	F _b	3.53	2.36	1.96	1.47	0.98

The part weight has been deducted in the above table.

I Section

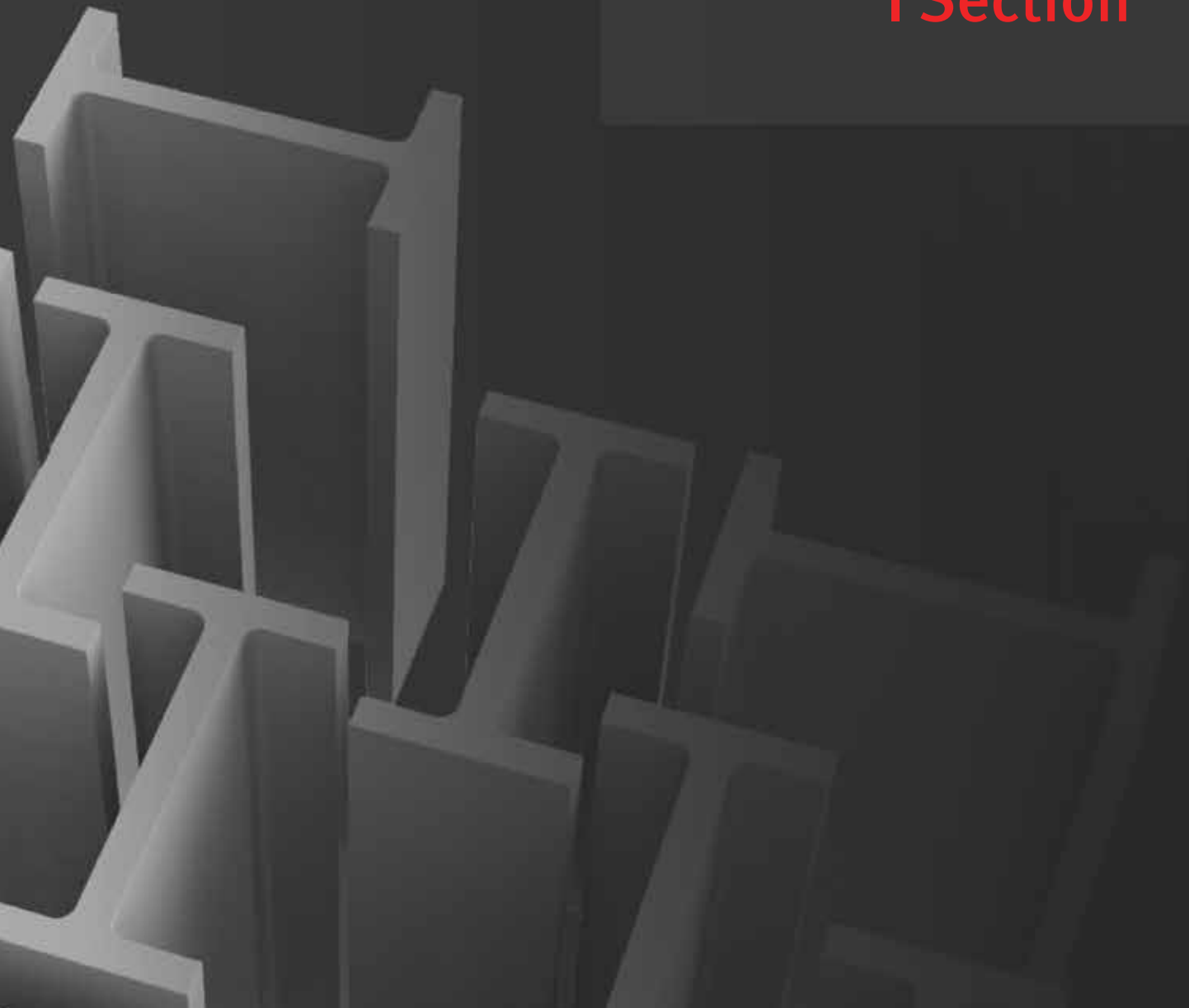

Beams - Allowable Uniform Loads

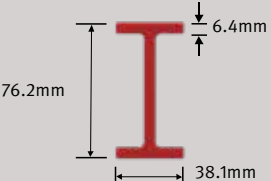
Part: 76.2 x 38.1 x 6.4mm							
Part Number: ARX-IS07603806							
			A_w	405.8mm ²	Wt.	1.6kg/m	
			I	7.27 x 10 ⁵ mm ⁴	S	19090mm ³	
Span (m)	Maximum Load (kN/m)		Deflection (kN/m)				
			L/100	L/150	L/180	L/240	L/360
1.2	6.97	F _v	5.27	3.51	2.93	2.20	1.46
1.5	4.68	F _b	2.76	1.84	1.53	1.15	0.77
1.8	3.25	F _b	1.62	1.08	0.90	0.67	0.45
2.1	2.39	F _b	1.03	0.68	0.57	0.43	0.29
2.4	1.83	F _b	0.69	0.46	0.38	0.29	0.19
2.7	1.44	F _b	0.49	0.32	0.27	0.20	0.14
3.0	1.17	F _b	0.36	0.24	0.20	0.15	0.10
The part weight has been deducted in the above table.							

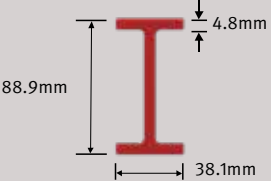
Part: 88.9 x 38.1 x 4.8mm							
Part Number: ARX-IS08903805							
			A_w	380.6mm ²	Wt.	1.3kg/m	
			I	8.41 x 10 ⁵ mm ⁴	S	18930mm ³	
Span (m)	Maximum Load (kN/m)		Deflection (kN/m)				
			L/100	L/150	L/180	L/240	L/360
1.2	6.53	F _v	6.01	4.01	3.34	2.50	1.67
1.5	4.64	F _b	3.16	2.11	1.76	1.32	0.88
1.8	3.22	F _b	1.86	1.24	1.03	0.77	0.52
2.1	2.37	F _b	1.18	0.79	0.66	0.49	0.33
2.4	1.81	F _b	0.80	0.53	0.44	0.33	0.22
2.7	1.43	F _b	0.56	0.37	0.31	0.23	0.16
3.0	1.16	F _b	0.41	0.27	0.23	0.17	0.11
The part weight has been deducted in the above table.							

Beams - Allowable Uniform Loads

Part: 101.6 x 50.8 x 6.4mm							
Part Number: ARX-IS10205106							
			A_w	568.3mm ²	Wt.	2.2kg/m	
			I	1.84 x 10 ⁶ mm ⁴	S	36167mm ³	
Span (m)	Maximum Load (kN/m)		Deflection (kN/m)				
			L/100	L/150	L/180	L/240	L/360
1.2	9.76	F _v	--	8.45	7.04	5.28	3.52
1.5	7.80	F _v	6.75	4.50	3.75	2.81	1.88
1.8	6.15	F _b	4.00	2.66	2.22	1.66	1.11
2.1	4.52	F _b	2.55	1.70	1.42	1.06	0.71
2.4	3.46	F _b	1.72	1.15	0.96	0.72	0.48
2.7	2.73	F _b	1.22	0.81	0.68	0.51	0.34
3.0	2.22	F _b	0.89	0.59	0.50	0.37	0.25
3.3	1.83	F _b	0.67	0.45	0.37	0.28	0.19
3.6	1.54	F _b	0.52	0.35	0.29	0.22	0.14

The part weight has been deducted in the above table.

Part: 139.7 x 63.5 x 6.4mm							
Part Number: ARX-IS14006406							
			A_w	812.2mm ²	Wt.	2.9kg/m	
			I	4.67 x 10 ⁶ mm ⁴	S	66883mm ³	
Span (m)	Maximum Load (kN/m)		Deflection (kN/m)				
			L/100	L/150	L/180	L/240	L/360
1.2	13.94	F _v	--	--	--	12.39	8.26
1.5	11.15	F _v	--	10.84	9.03	6.77	4.52
1.8	9.29	F _v	9.77	6.51	5.43	4.07	2.71
2.1	7.97	F _v	6.30	4.20	3.50	2.62	1.75
2.4	6.40	F _b	4.29	2.86	2.38	1.79	1.19
2.7	5.06	F _b	3.04	2.03	1.69	1.27	0.85
3.0	4.10	F _b	2.24	1.49	1.24	0.93	0.62
3.3	3.39	F _b	1.69	1.13	0.94	0.70	0.47
3.6	2.84	F _b	1.31	0.87	0.73	0.54	0.36
3.9	2.42	F _b	1.03	0.69	0.57	0.43	0.29
4.2	2.09	F _b	0.83	0.55	0.46	0.35	0.23
4.5	1.82	F _b	0.67	0.45	0.37	0.28	0.19

The part weight has been deducted in the above table.

Beams - Allowable Uniform Loads

Part: 152.4 x 76.2 x 6.4mm							
Part Number: ARX-IS15207606							
			A_w	893.4mm ²	Wt.	3.3kg/m	
			I	6.61 x 10 ⁶ mm ⁴	S	86701mm ³	
Span (m)	Maximum Load (kN/m)		Deflection (kN/m)				
			L/100	L/150	L/180	L/240	L/360
1.5	12.27	F _v	--	--	--	9.26	6.17
1.8	10.22	F _v	--	8.99	7.49	5.62	3.74
2.1	8.76	F _v	8.74	5.83	4.86	3.64	2.43
2.4	7.67	F _v	5.97	3.98	3.32	2.49	1.66
2.7	6.56	F _b	4.25	2.84	2.36	1.77	1.18
3.0	5.31	F _b	3.13	2.09	1.74	1.30	0.87
3.3	4.39	F _b	2.37	1.58	1.32	0.99	0.66
3.6	3.69	F _b	1.84	1.22	1.02	0.76	0.51
3.9	3.14	F _b	1.45	0.97	0.81	0.60	0.40
4.2	2.71	F _b	1.17	0.78	0.65	0.49	0.32
4.5	2.36	F _b	0.95	0.63	0.53	0.40	0.26
The part weight has been deducted in the above table.							

Part: 152.4 x 76.2 x 9.5mm							
Part Number: ARX-IS15207610							
			A_w	1267.3mm ²	Wt.	4.9kg/m	
			I	9.30 x 10 ⁶ mm ⁴	S	122063mm ³	
Span (m)	Maximum Load (kN/m)		Deflection (kN/m)				
			L/100	L/150	L/180	L/240	L/360
1.5	17.40	F _v	--	--	17.40	13.05	8.70
1.8	14.50	F _v	--	12.66	10.55	7.91	5.28
2.1	12.43	F _v	12.32	8.21	6.84	5.13	3.42
2.4	10.88	F _v	8.41	5.61	4.67	3.51	2.34
2.7	9.23	F _b	5.99	3.99	3.33	2.50	1.66
3.0	7.48	F _b	4.41	2.94	2.45	1.84	1.22
3.3	6.18	F _b	3.34	2.22	1.85	1.39	0.93
3.6	5.19	F _b	2.59	1.72	1.44	1.08	0.72
3.9	4.42	F _b	2.04	1.36	1.13	0.85	0.57
4.2	3.81	F _b	1.64	1.09	0.91	0.68	0.46
4.5	3.32	F _b	1.34	0.89	0.74	0.56	0.37
4.8	2.92	F _b	1.10	0.74	0.61	0.46	0.31
5.1	2.59	F _b	0.92	0.62	0.51	0.38	0.26
5.4	2.31	F _b	0.78	0.52	0.43	0.32	0.22
The part weight has been deducted in the above table.							

Part: 203.2 x 101.6 x 9.5m							
Part Number: ARX-IS20310210							
			A_w	1749.9mm ²	Wt.	6.6kg/m	
			I	2.31 x 10 ⁷ mm ⁴	S	227572mm ³	
Span (m)	Maximum Load (kN/m)		Deflection (kN/m)				
			L/100	L/150	L/180	L/240	L/360
1.2	30.04	F _v	----	----	----	----	----
1.5	24.03	F _v	----	----	----	----	19.32
1.8	20.03	F _v	----	----	----	18.10	12.07
2.1	17.17	F _v	----	----	15.96	11.97	7.98
2.4	15.02	F _v	----	13.26	11.05	8.29	5.53
2.7	13.35	F _v	----	9.53	7.94	5.96	3.97
3.0	12.02	F _v	10.60	7.07	5.89	4.42	2.95
3.3	10.92	F _v	8.07	5.38	4.48	3.36	2.24
3.6	9.68	F _b	6.28	4.19	3.49	2.62	1.74
3.9	8.25	F _b	4.98	3.32	2.76	2.07	1.38
4.2	7.11	F _b	4.01	2.67	2.23	1.67	1.11
4.5	6.19	F _b	3.28	2.18	1.82	1.36	0.91
4.8	5.44	F _b	2.71	1.81	1.51	1.13	0.75
5.1	4.82	F _b	2.27	1.51	1.26	0.94	0.63
5.4	4.30	F _b	1.92	1.28	1.06	0.80	0.53
5.7	3.86	F _b	1.63	1.09	0.91	0.68	0.45
6.0	3.48	F _b	1.17	1.24	1.21	1.09	0.85

The part weight has been deducted in the above table.

Beams - Allowable Uniform Loads

Part: 203.2 x 101.6 x 12.7mm							
Part Number: ARX-IS20310213							
			A_w	2258.1mm ²	Wt.	8.7kg/m	
			I	2.94×10^7 mm ⁴	S	289334mm ³	
Span (m)	Maximum Load (kN/m)		Deflection (kN/m)				
			L/100	L/150	L/180	L/240	L/360
1.8	25.84	F_v	--	--	--	23.07	15.38
2.1	22.15	F_v	--	--	20.33	15.25	10.17
2.4	19.38	F_v	--	16.89	14.07	10.55	7.04
2.7	17.23	F_v	--	12.14	10.11	7.59	5.06
3.0	15.51	F_v	13.50	9.00	7.50	5.62	3.75
3.3	14.10	F_v	10.27	6.85	5.71	4.28	2.85
3.6	12.31	F_b	7.99	5.32	4.44	3.33	2.22
3.9	10.49	F_b	6.33	4.22	3.52	2.64	1.76
4.2	9.04	F_b	5.10	3.40	2.83	2.12	1.42
4.5	7.88	F_b	4.17	2.78	2.31	1.74	1.16
4.8	6.92	F_b	3.45	2.30	1.92	1.44	0.96
5.1	6.13	F_b	2.88	1.92	1.60	1.20	0.80
5.4	5.47	F_b	2.44	1.62	1.35	1.02	0.68
5.7	4.91	F_b	2.08	1.38	1.15	0.87	0.58
6.0	4.43	F_b	1.78	1.19	0.99	0.74	0.50

The part weight has been deducted in the above table.

Beams - Allowable Uniform Loads

Part: 254 x 127 x 9.5mm							
Part Number: ARX-IS25412710							
			A_w	2232.5mm ²	Wt.	8.4kg/m	
			I	4.65 x 10 ⁷ mm ⁴	S	365849mm ³	
Span (m)	Maximum Load (kN/m)		Deflection (kN/m)				
			L/100	L/150	L/180	L/240	L/360
2.1	21.90	F _v	--	--	--	--	14.85
2.4	19.16	F _v	--	--	--	15.66	10.44
2.7	17.03	F _v	--	--	15.19	11.39	7.59
3.0	15.33	F _v	--	13.63	11.36	8.52	5.68
3.3	13.94	F _v	--	10.44	8.70	6.53	4.35
3.6	12.77	F _v	12.25	8.17	6.80	5.10	3.40
3.9	11.79	F _v	9.75	6.50	5.42	4.06	2.71
4.2	10.95	F _v	7.88	5.25	4.38	3.28	2.19
4.5	9.96	F _b	6.46	4.30	3.59	2.69	1.79
4.8	8.75	F _b	5.35	3.57	2.97	2.23	1.49
5.1	7.75	F _b	4.49	2.99	2.49	1.87	1.25
5.4	6.92	F _b	3.80	2.53	2.11	1.58	1.05
5.7	6.21	F _b	3.24	2.16	1.80	1.35	0.90
6.0	5.60	F _b	2.79	1.86	1.55	1.16	0.77
6.3	5.08	F _b	2.41	1.61	1.34	1.01	0.67
6.6	4.63	F _b	2.11	1.40	1.17	0.88	0.58
6.9	4.24	F _b	1.85	1.23	1.03	0.77	0.51
7.2	3.89	F _b	1.63	1.09	0.90	0.68	0.45
7.5	3.58	F _b	1.44	0.96	0.80	0.60	0.40

The part weight has been deducted in the above table.

Beams - Allowable Uniform Loads

Part: 254 x 127 x 12.7mm							
Part Number: ARX-IS25412713							
			A_w	2903.2mm ²	Wt.	11.0kg/m	
			I	5.96 x 10 ⁷ mm ⁴	S	469626mm ³	
Span (m)	Maximum Load (kN/m)		Deflection (kN/m)				
			L/100	L/150	L/180	L/240	L/360
2.1	28.48	F _v	--	--	--	--	19.11
2.4	24.92	F _v	--	--	--	20.15	13.43
2.7	22.15	F _v	--	--	19.53	14.65	9.77
3.0	19.94	F _v	--	17.52	14.60	10.95	7.30
3.3	18.12	F _v	--	13.42	11.18	8.39	5.59
3.6	16.61	F _v	15.74	10.49	8.74	6.56	4.37
3.9	15.33	F _v	12.52	8.35	6.96	5.22	3.48
4.2	14.24	F _v	10.12	6.75	5.62	4.22	2.81
4.5	12.78	F _b	8.29	5.53	4.61	3.46	2.30
4.8	11.24	F _b	6.88	4.58	3.82	2.87	1.91
5.1	9.95	F _b	5.76	3.84	3.20	2.40	1.60
5.4	8.88	F _b	4.88	3.25	2.71	2.03	1.35
5.7	7.97	F _b	4.16	2.77	2.31	1.73	1.16
6.0	7.19	F _b	3.58	2.39	1.99	1.49	0.99
6.3	6.52	F _b	3.10	2.07	1.72	1.29	0.86
6.6	5.94	F _b	2.70	1.80	1.50	1.13	0.75
6.9	5.44	F _b	2.37	1.58	1.32	0.99	0.66
7.2	4.99	F _b	2.09	1.39	1.16	0.87	0.58
7.5	4.60	F _b	1.85	1.24	1.03	0.77	0.51

The part weight has been deducted in the above table.

Beams - Allowable Uniform Loads

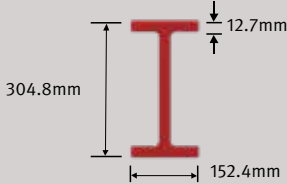
Part: 304.8 x 152.4 x 12.7mm							
Part Number: ARX-IS30515213							
			A_w	3548mm ²	Wt.	13.4kg/m	
			I	1.06 x 10 ⁸ mm ⁴	S	693605mm ³	
Span (m)	Maximum Load (kN/m)		Deflection (kN/m)				
			L/100	L/150	L/180	L/240	L/360
2.1	34.81	F _v	--	--	--	--	31.06
2.4	30.46	F _v	--	--	--	--	22.20
2.7	27.07	F _v	--	--	--	24.51	16.34
3.0	24.37	F _v	--	--	--	18.50	12.33
3.3	22.15	F _v	--	--	19.03	14.27	9.52
3.6	20.30	F _v	--	17.96	14.97	11.22	7.48
3.9	18.74	F _v	--	14.36	11.97	8.97	5.98
4.2	17.40	F _v	--	11.65	9.71	7.28	4.85
4.5	16.24	F _v	14.36	9.58	7.98	5.98	3.99
4.8	15.23	F _v	11.94	7.96	6.63	4.98	3.32
5.1	14.33	F _v	10.03	6.69	5.57	4.18	2.79
5.4	13.11	F _b	8.50	5.67	4.72	3.54	2.36
5.7	11.77	F _b	7.27	4.85	4.04	3.03	2.02
6.0	10.62	F _b	6.26	4.17	3.48	2.61	1.74
6.3	9.63	F _b	5.43	3.62	3.02	2.26	1.51
6.6	8.78	F _b	4.74	3.16	2.63	1.97	1.32
6.9	8.03	F _b	4.16	2.77	2.31	1.73	1.16
7.2	7.37	F _b	3.67	2.45	2.04	1.53	1.02
7.5	6.80	F _b	3.26	2.17	1.81	1.36	0.90
7.8	6.28	F _b	2.90	1.93	1.61	1.21	0.81
8.1	5.83	F _b	2.59	1.73	1.44	1.08	0.72
8.4	5.42	F _b	2.33	1.55	1.29	0.97	0.65
8.7	5.05	F _b	2.10	1.40	1.17	0.88	0.58
9.0	4.72	F _b	1.90	1.27	1.06	0.79	0.53

The part weight has been deducted in the above table.

Beams - Allowable Uniform Loads

Part: 457.2 x 9.5 x 114.3 x 12.7mm							
Part Number: ARX-IS45711413							
			A_w	4102.1mm ²	Wt.	12.6kg/m	
			I	2.07 x 10 ⁸ mm ⁴	S	907035mm ³	
Span (m)	Maximum Load (kN/m)		Deflection (kN/m)				
			L/100	L/150	L/180	L/240	L/360
1.8	46.95	F _v	--	--	--	--	--
2.1	40.24	F _v	--	--	--	--	--
2.4	35.21	F _v	--	--	--	--	--
2.7	31.30	F _v	--	--	--	--	28.47
3.0	28.17	F _v	--	--	--	--	21.88
3.3	25.61	F _v	--	--	--	--	17.13
3.6	23.47	F _v	--	--	--	20.45	13.63
3.9	21.67	F _v	--	--	--	16.51	11.00
4.2	20.12	F _v	--	--	18.00	13.50	9.00
4.5	18.78	F _v	--	17.87	14.89	11.17	7.45
4.8	17.60	F _v	--	14.94	12.45	9.34	6.22
5.1	16.57	F _v	--	12.61	10.50	7.88	5.25
5.4	15.65	F _v	--	10.73	8.94	6.71	4.47
5.7	14.83	F _v	13.80	9.20	7.67	5.75	3.83
6.0	13.89	F _b	11.93	7.95	6.63	4.97	3.31
6.3	12.60	F _b	10.37	6.91	5.76	4.32	2.88
6.6	11.48	F _b	9.07	6.05	5.04	3.78	2.52
6.9	10.50	F _b	7.98	5.32	4.43	3.32	2.22
7.2	9.64	F _b	7.05	4.70	3.92	2.94	1.96
7.5	8.89	F _b	6.26	4.18	3.48	2.61	1.74
7.8	8.22	F _b	5.59	3.73	3.10	2.33	1.55
8.1	7.62	F _b	5.01	3.34	2.78	2.09	1.39
8.4	7.09	F _b	4.50	3.00	2.50	1.88	1.25
8.7	6.61	F _b	4.06	2.71	2.26	1.69	1.13
9.0	6.17	F _b	3.68	2.45	2.04	1.53	1.02

The part weight has been deducted in the above table.

Beams - Allowable Uniform Loads

Part: 609.6 x 9.5 x 190.5 x 19.1mm							
Part Number: ARX-IS61019119							
			A_w	5428.3mm ²	Wt.	22.9kg/m	
			I	7.81 x 10 ⁸ mm ⁴	S	2562959mm ³	
Span (m)	Maximum Load (kN/m)		Deflection (kN/m)				
			L/100	L/150	L/180	L/240	L/360
3.0	37.27	F _v	--	--	--	--	--
3.3	33.89	F _v	--	--	--	--	--
3.6	31.06	F _v	--	--	--	--	--
3.9	28.67	F _v	--	--	--	--	--
4.2	26.62	F _v	--	--	--	--	--
4.5	24.85	F _v	--	--	--	--	23.01
4.8	23.30	F _v	--	--	--	--	19.62
5.1	21.93	F _v	--	--	--	--	16.84
5.4	20.71	F _v	--	--	--	--	14.55
5.7	19.62	F _v	--	--	--	18.96	12.64
6.0	18.64	F _v	--	--	--	16.57	11.05
6.3	17.75	F _v	--	--	--	14.55	9.70
6.6	16.94	F _v	--	--	--	12.84	8.56
6.9	16.21	F _v	--	--	15.18	11.39	7.59
7.2	15.53	F _v	--	--	13.52	10.14	6.76
7.5	14.91	F _v	--	14.50	12.08	9.06	6.04
7.8	14.34	F _v	--	13.01	10.84	8.13	5.42
8.1	13.81	F _v	--	11.71	9.76	7.32	4.88
8.4	13.31	F _v	--	10.58	8.82	6.61	4.41
8.7	12.85	F _v	--	9.59	7.99	5.99	3.99
9.0	12.42	F _v	--	8.71	7.26	5.45	3.63
9.3	12.02	F _v	11.91	7.94	6.62	4.96	3.31
9.6	11.65	F _v	10.88	7.26	6.05	4.53	3.02
9.9	11.30	F _v	9.97	6.65	5.54	4.15	2.77
10.2	10.96	F _v	9.15	6.10	5.09	3.81	2.54
10.5	10.65	F _v	8.43	5.62	4.68	3.51	2.34
10.8	10.35	F _v	7.77	5.18	4.32	3.24	2.16
11.1	10.07	F _v	7.18	4.79	3.99	2.99	1.99
11.4	9.81	F _v	6.65	4.43	3.69	2.77	1.85
11.7	9.56	F _v	6.17	4.11	3.43	2.57	1.71
12.0	9.32	F _v	5.73	3.82	3.18	2.39	1.59

The part weight has been deducted in the above table.

WF Section



Beams - Allowable Uniform Loads

Part: 76.2 x 6.4mm							
Part Number: ARX-WF07606							
			A_w	405.8mm ²	Wt.	2.5kg/m	
			I	1.32 x 10 ⁶ mm ⁴	S	34577mm ³	
Span (m)	Maximum Load (kN/m)		Deflection (kN/m)				
			L/100	L/150	L/180	L/240	L/360
1.2	6.97	F _v	--	6.06	5.05	3.79	2.53
1.5	5.57	F _v	4.85	3.23	2.69	2.02	1.35
1.8	4.64	F _v	2.87	1.91	1.59	1.20	0.80
2.1	3.98	F _v	1.83	1.22	1.02	0.76	0.51
2.4	3.31	F _b	1.24	0.83	0.69	0.52	0.34
2.7	2.61	F _b	0.87	0.58	0.49	0.36	0.24
3.0	2.12	F _b	0.64	0.43	0.36	0.27	0.18
The part weight has been deducted in the above table.							

Part: 101.6 x 6.4mm							
Part Number: ARX-WF10206							
			A_w	568.3mm ²	Wt.	3.4kg/m	
			I	3.30 x 10 ⁶ mm ⁴	S	65057mm ³	
Span (m)	Maximum Load (kN/m)		Deflection (kN/m)				
			L/100	L/150	L/180	L/240	L/360
1.2	9.76	F _v	--	--	--	8.75	5.83
1.5	7.80	F _v	--	7.66	6.38	4.79	3.19
1.8	6.50	F _v	--	4.60	3.84	2.88	1.92
2.1	5.57	F _v	4.45	2.97	2.47	1.86	1.24
2.4	4.88	F _v	3.03	2.02	1.68	1.26	0.84
2.7	4.34	F _v	2.15	1.43	1.20	0.90	0.60
3.0	3.90	F _v	1.58	1.05	0.88	0.66	0.44
3.3	3.29	F _b	1.19	0.80	0.66	0.50	0.33
3.6	2.77	F _b	0.92	0.62	0.51	0.39	0.26
3.9	2.36	F _b	0.73	0.49	0.41	0.30	0.20
4.2	2.03	F _b	0.59	0.39	0.33	0.24	0.16
The part weight has been deducted in the above table.							

Beams - Allowable Uniform Loads

Part: 152.4 x 6.4mm							
Part Number: ARX-WF15206							
			A_w	893.4mm ²	Wt.	5.1kg/m	
			I	1.18 x 10 ⁷ mm ⁴	S	154530mm ³	
Span (m)	Maximum Load (kN/m)		Deflection (kN/m)				
			L/100	L/150	L/180	L/240	L/360
1.5	12.27	F _v	--	--	--	--	9.84
1.8	10.22	F _v	--	--	--	9.22	6.15
2.1	8.76	F _v	--	--	8.13	6.10	4.06
2.4	7.67	F _v	--	6.75	5.63	4.22	2.81
2.7	6.82	F _v	--	4.85	4.05	3.03	2.02
3.0	6.13	F _v	5.40	3.60	3.00	2.25	1.50
3.3	5.58	F _v	4.11	2.74	2.28	1.71	1.14
3.6	5.11	F _v	3.20	2.13	1.78	1.33	0.89
3.9	4.72	F _v	2.53	1.69	1.41	1.06	0.70
4.2	4.38	F _v	2.04	1.36	1.13	0.85	0.57
4.5	4.09	F _v	1.67	1.11	0.93	0.69	0.46

The part weight has been deducted in the above table.

Part: 152.4 x 9.5mm							
Part Number: ARX-WF15210							
			A_w	1267.3mm ²	Wt.	7.5kg/m	
			I	1.67 x 10 ⁷ mm ⁴	S	219423mm ³	
Span (m)	Maximum Load (kN/m)		Deflection (kN/m)				
			L/100	L/150	L/180	L/240	L/360
1.2	21.76	F _v	--	--	--	--	--
1.5	17.40	F _v	--	--	--	--	13.97
1.8	14.50	F _v	--	--	--	13.09	8.73
2.1	12.43	F _v	--	--	11.54	8.66	5.77
2.4	10.88	F _v	--	9.59	7.99	5.99	4.00
2.7	9.67	F _v	--	6.90	5.75	4.31	2.87
3.0	8.70	F _v	7.67	5.11	4.26	3.20	2.13
3.3	7.91	F _v	5.84	3.89	3.24	2.43	1.62
3.6	7.25	F _v	4.54	3.03	2.52	1.89	1.26
3.9	6.69	F _v	3.60	2.40	2.00	1.50	1.00
4.2	6.22	F _v	2.90	1.93	1.61	1.21	0.81
4.5	5.80	F _v	2.37	1.58	1.32	0.99	0.66

The part weight has been deducted in the above table.

Beams - Allowable Uniform Loads

Part: 203.2 x 9.5mm							
Part Number: ARX-WF20310							
			A_w	1749.9mm ²	Wt.	10.1kg/m	
			I	4.13×10^7 mm ⁴	S	406399mm ³	
Span (m)	Maximum Load (kN/m)		Deflection (kN/m)				
			L/100	L/150	L/180	L/240	L/360
1.2	30.04	F_v	--	--	--	--	--
1.5	24.03	F_v	--	--	--	--	--
1.8	20.03	F_v	--	--	--	--	18.87
2.1	17.17	F_v	--	--	--	--	12.85
2.4	15.02	F_v	--	--	--	13.62	9.08
2.7	13.35	F_v	--	--	13.26	9.94	6.63
3.0	12.02	F_v	--	11.94	9.95	7.46	4.97
3.3	10.92	F_v	--	9.16	7.64	5.73	3.82
3.6	10.01	F_v	--	7.18	5.98	4.49	2.99
3.9	9.24	F_v	8.58	5.72	4.77	3.58	2.38
4.2	8.58	F_v	6.95	4.63	3.86	2.89	1.93
4.5	8.01	F_v	5.70	3.80	3.16	2.37	1.58
4.8	7.51	F_v	4.73	3.15	2.63	1.97	1.31
5.1	7.07	F_v	3.97	2.64	2.20	1.65	1.10
5.4	6.68	F_v	3.36	2.24	1.87	1.40	0.93
5.7	6.32	F_v	2.87	1.91	1.59	1.19	0.80
6.0	6.01	F_v	2.47	1.64	1.37	1.03	0.69
The part weight has been deducted in the above table.							

Beams - Allowable Uniform Loads

Part: 203.2 x 12.7mm							
Part Number: ARX-WF20313							
			A_w	2258.1mm ²	Wt.	13.4kg/m	
			I	5.28 x 10 ⁷ mm ⁴	S	520125mm ³	
Span (m)	Maximum Load (kN/m)		Deflection (kN/m)				
			L/100	L/150	L/180	L/240	L/360
1.8	25.84	F _v	--	--	--	--	24.21
2.1	22.15	F _v	--	--	--	--	16.47
2.4	19.38	F _v	--	--	--	17.46	11.64
2.7	17.23	F _v	--	--	16.99	12.74	8.50
3.0	15.51	F _v	--	15.29	12.74	9.56	6.37
3.3	14.10	F _v	--	11.74	9.78	7.34	4.89
3.6	12.92	F _v	--	9.20	7.66	5.75	3.83
3.9	11.93	F _v	10.99	7.33	6.11	4.58	3.05
4.2	11.08	F _v	8.90	5.93	4.94	3.71	2.47
4.5	10.34	F _v	7.30	4.86	4.05	3.04	2.03
4.8	9.69	F _v	6.05	4.04	3.36	2.52	1.68
5.1	9.12	F _v	5.08	3.38	2.82	2.12	1.41
5.4	8.61	F _v	4.30	2.87	2.39	1.79	1.19
5.7	8.16	F _v	3.67	2.45	2.04	1.53	1.02
6.0	7.75	F _v	3.16	2.11	1.75	1.32	0.88
6.3	7.22	F _b	2.74	1.82	1.52	1.14	0.76
6.6	6.58	F _b	2.39	1.59	1.33	0.99	0.66
6.9	6.02	F _b	2.09	1.40	1.16	0.87	0.58
7.2	5.53	F _b	1.85	1.23	1.03	0.77	0.51
7.5	5.10	F _b	1.64	1.09	0.91	0.68	0.45

The part weight has been deducted in the above table.

Beams - Allowable Uniform Loads

Part: 254 x 9.5mm							
Part Number: ARX-WF25410							
			A_w	2232.5mm ²	Wt.	12.8kg/m	
			I	8.26 x 10 ⁷ mm ⁴	S	650730mm ³	
Span (m)	Maximum Load (kN/m)		Deflection (kN/m)				
			L/100	L/150	L/180	L/240	L/360
2.1	21.90	F _v	--	--	--	--	--
2.4	19.16	F _v	--	--	--	--	16.48
2.7	17.03	F _v	--	--	--	--	12.24
3.0	15.33	F _v	--	--	--	13.95	9.30
3.3	13.94	F _v	--	--	--	10.82	7.21
3.6	12.77	F _v	--	--	11.40	8.55	5.70
3.9	11.79	F _v	--	10.97	9.14	6.86	4.57
4.2	10.95	F _v	--	8.93	7.44	5.58	3.72
4.5	10.22	F _v	--	7.35	6.13	4.60	3.06
4.8	9.58	F _v	9.19	6.13	5.11	3.83	2.55
5.1	9.02	F _v	7.73	5.15	4.30	3.22	2.15
5.4	8.52	F _v	6.56	4.38	3.65	2.73	1.82
5.7	8.07	F _v	5.62	3.75	3.12	2.34	1.56
6.0	7.66	F _v	4.84	3.23	2.69	2.02	1.35
6.3	7.30	F _v	4.20	2.80	2.34	1.75	1.17
6.6	6.97	F _v	3.67	2.45	2.04	1.53	1.02
6.9	6.67	F _v	3.23	2.15	1.79	1.34	0.90
7.2	6.39	F _v	2.85	1.90	1.58	1.19	0.79
7.5	6.13	F _v	2.53	1.69	1.40	1.05	0.70

The part weight has been deducted in the above table.

Beams - Allowable Uniform Loads

Part: 254 x 12.7mm							
Part Number: ARX-WF25413							
			A_w	2903.2mm ²	Wt.	16.9kg/m	
			I	$1.07 \times 10^8 \text{ mm}^4$	S	839673mm ³	
Span (m)	Maximum Load (kN/m)		Deflection (kN/m)				
			L/100	L/150	L/180	L/240	L/360
2.1	28.48	F_v	--	--	--	--	--
2.4	24.92	F_v	--	--	--	--	21.31
2.7	22.15	F_v	--	--	--	--	15.82
3.0	19.94	F_v	--	--	--	18.03	12.02
3.3	18.12	F_v	--	--	--	13.98	9.32
3.6	16.61	F_v	--	--	14.72	11.04	7.36
3.9	15.33	F_v	--	14.17	11.81	8.86	5.90
4.2	14.24	F_v	--	11.53	9.61	7.21	4.80
4.5	13.29	F_v	--	9.50	7.91	5.94	3.96
4.8	12.46	F_v	11.87	7.91	6.59	4.94	3.30
5.1	11.73	F_v	9.98	6.66	5.55	4.16	2.77
5.4	11.08	F_v	8.47	5.65	4.71	3.53	2.35
5.7	10.49	F_v	7.25	4.84	4.03	3.02	2.01
6.0	9.97	F_v	6.25	4.17	3.47	2.61	1.74
6.3	9.49	F_v	5.43	3.62	3.02	2.26	1.51
6.6	9.06	F_v	4.74	3.16	2.63	1.98	1.32
6.9	8.67	F_v	4.16	2.78	2.31	1.74	1.16
7.2	8.31	F_v	3.68	2.45	2.04	1.53	1.02
7.5	7.97	F_v	3.26	2.18	1.81	1.36	0.91
7.8	7.61	F_b	2.91	1.94	1.62	1.21	0.81
8.1	7.05	F_b	2.60	1.74	1.45	1.08	0.72
8.4	6.56	F_b	2.34	1.56	1.30	0.97	0.65
8.7	6.11	F_b	2.11	1.41	1.17	0.88	0.59
9.0	5.71	F_b	1.91	1.27	1.06	0.80	0.53

The part weight has been deducted in the above table.

Beams - Allowable Uniform Loads

Part: 304.8 x 12.7mm							
Part Number: ARX-WF30513							
			A_w	3548.4mm ²	Wt.	20.3kg/m	
			I	1.88 x 10 ⁸ mm ⁴	S	1236404mm ³	
Span (m)	Maximum Load (kN/m)		Deflection (kN/m)				
			L/100	L/150	L/180	L/240	L/360
2.1	34.81	F _v	--	--	--	--	--
2.4	30.46	F _v	--	--	--	--	--
2.7	27.07	F _v	--	--	--	--	25.51
3.0	24.37	F _v	--	--	--	--	19.65
3.3	22.15	F _v	--	--	--	--	15.41
3.6	20.30	F _v	--	--	--	18.41	12.27
3.9	18.74	F _v	--	--	--	14.88	9.92
4.2	17.40	F _v	--	--	16.24	12.18	8.12
4.5	16.24	F _v	--	16.13	13.44	10.08	6.72
4.8	15.23	F _v	--	13.50	11.25	8.43	5.62
5.1	14.33	F _v	--	11.39	9.50	7.12	4.75
5.4	13.54	F _v	--	9.70	8.09	6.06	4.04
5.7	12.82	F _v	12.49	8.33	6.94	5.20	3.47
6.0	12.18	F _v	10.79	7.20	6.00	4.50	3.00
6.3	11.60	F _v	9.39	6.26	5.22	3.91	2.61
6.6	11.08	F _v	8.21	5.48	4.56	3.42	2.28
6.9	10.59	F _v	7.23	4.82	4.01	3.01	2.01
7.2	10.15	F _v	6.39	4.26	3.55	2.66	1.77
7.5	9.75	F _v	5.68	3.78	3.15	2.37	1.58
7.8	9.37	F _v	5.07	3.38	2.81	2.11	1.41
8.1	9.02	F _v	4.54	3.03	2.52	1.89	1.26
8.4	8.70	F _v	4.08	2.72	2.27	1.70	1.13
8.7	8.40	F _v	3.68	2.46	2.05	1.53	1.02
9.0	8.12	F _v	3.33	2.22	1.85	1.39	0.93
9.3	7.86	F _v	3.03	2.02	1.68	1.26	0.84
9.6	7.39	F _b	2.76	1.84	1.53	1.15	0.77
9.9	6.95	F _b	2.52	1.68	1.40	1.05	0.70
10.2	6.55	F _b	2.31	1.54	1.28	0.96	0.64
10.5	6.18	F _b	2.12	1.41	1.18	0.88	0.59

The part weight has been deducted in the above table.



Double Web Section

Beams - Allowable Uniform Loads

Part: 475 X 225 x 10 x 16mm							
Part Number: ARX-DW4752251016							
			A_w	8900mm ²	Wt.	28.9kg/m	
			I	524000000mm ⁴	S	2210000mm ³	
Span (m)	Maximum Load (N/m)		Deflection (N/m)				
			L/100	L/150	L/180	L/240	L/360
4.27	50659	----	----	----	----	21276	----
4.57	46085	----	----	----	----	17689	----
4.88	41934	----	----	----	----	14768	----
5.18	38393	----	----	----	18772	12514	----
5.49	35155	----	----	21272	15954	10636	----
5.79	32374	----	----	21973	18310	13733	9155
6.10	29812	----	----	18953	15794	11846	7897
6.40	27597	----	----	16530	13775	10331	6888
6.71	25546	----	----	14437	12031	9023	6016
7.01	23760	----	19099	12733	10611	7958	5303
7.32	20638	----	15010	10007	8339	6254	4169
7.62	19315	----	13420	8947	7456	5592	3728
7.92	18072	----	12003	8002	6668	5001	3334
8.23	16976	----	10814	7209	6008	4506	3004
8.53	15941	----	9744	6496	5413	4060	2707
8.84	15024	----	8838	5892	4910	3683	2455
9.14	14155	----	8016	5344	4453	3340	2227
9.45	13382	----	7313	4876	4063	3047	2032
9.75	12645	----	6671	4447	3706	2780	1853
10.06	11987	----	6119	4079	3399	2550	1700
10.36	11359	----	5610	3740	3117	2338	1558

The part weight has been deducted in the above table.

Beams - Allowable Uniform Loads

Part: 610mm X 203mm							
Part Number: ARX-DW6102030818							
		A_w	9177.6mm ²	Wt	35.6 kg/m		
		I	985921204mm ⁴	S	3234649.619mm ³		
Span (m)	Maximum Load (kN/m)	Deflection (kN/m)					
		L/150	L/200	L/250	L/300	L/350	L/400
5	64.1	57.1	42.8	34.2	28.5	24.5	21.4
6	44.5	35.0	26.3	21.0	17.5	15.0	13.1
7	32.7	22.9	17.2	13.7	11.5	9.8	8.6
8	25.1	15.7	11.8	9.4	7.9	6.7	5.9
9	19.8	11.2	8.4	6.7	5.6	4.8	4.2
10	16.0	8.3	6.2	5.0	4.2	3.6	3.1
11	13.3	6.3	4.7	3.8	3.1	2.7	2.4
12	11.1	4.9	3.7	2.9	2.4	2.1	1.8
13	9.5	3.9	2.9	2.3	1.9	1.7	1.4
14	8.2	3.1	2.3	1.9	1.6	1.3	1.2
15	7.1	2.5	1.9	1.5	1.3	1.1	1.0
16	6.3	2.1	1.6	1.3	1.0	0.9	0.8
17	5.5	1.8	1.3	1.1	0.9	0.8	0.7
18	4.9	1.5	1.1	0.9	0.7	0.6	0.6
19	4.4	1.3	0.9	0.8	0.6	0.5	0.5
20	4.0	1.1	0.8	0.6	0.5	0.5	0.4
The part weight has been deducted in the above table.							

Beams - Allowable Uniform Loads

Part: 914mm X 254mm							
Part Number: ARX-DW9142540916							
			A_w	15000.8mm ²	Wt	49.7 kg/m	
			I	2868340400 mm ⁴	S	6273710.411mm ³	
Span (m)	Maximum Load (kN/m)	Deflection (kN/m)					
		L/150	L/200	L/250	L/300	L/350	L/400
5	123.6	144.8	108.6	86.9	72.4	62.1	54.3
6	86.5	92.0	69.0	55.2	46.0	39.4	34.5
7	63.6	61.6	46.2	37.0	30.8	26.4	23.1
8	48.7	43.0	32.3	25.8	21.5	18.4	16.1
9	38.5	31.1	23.3	18.7	15.6	13.3	11.7
10	31.1	23.2	17.4	13.9	11.6	9.9	8.7
11	25.7	17.7	13.3	10.6	8.9	7.6	6.6
12	21.6	13.8	10.4	8.3	6.9	5.9	5.2
13	18.4	11.0	8.2	6.6	5.5	4.7	4.1
14	15.9	8.9	6.6	5.3	4.4	3.8	3.3
15	13.8	7.2	5.4	4.3	3.6	3.1	2.7
16	12.2	6.0	4.5	3.6	3.0	2.6	2.3
17	10.8	5.0	3.8	3.0	2.5	2.2	1.9
18	9.6	4.2	3.2	2.5	2.1	1.8	1.6
19	8.6	3.6	2.7	2.2	1.8	1.6	1.4
20	7.8	3.1	2.3	1.9	1.6	1.3	1.2
The part weight has been deducted in the above table.							

Rectangular Hollow Section

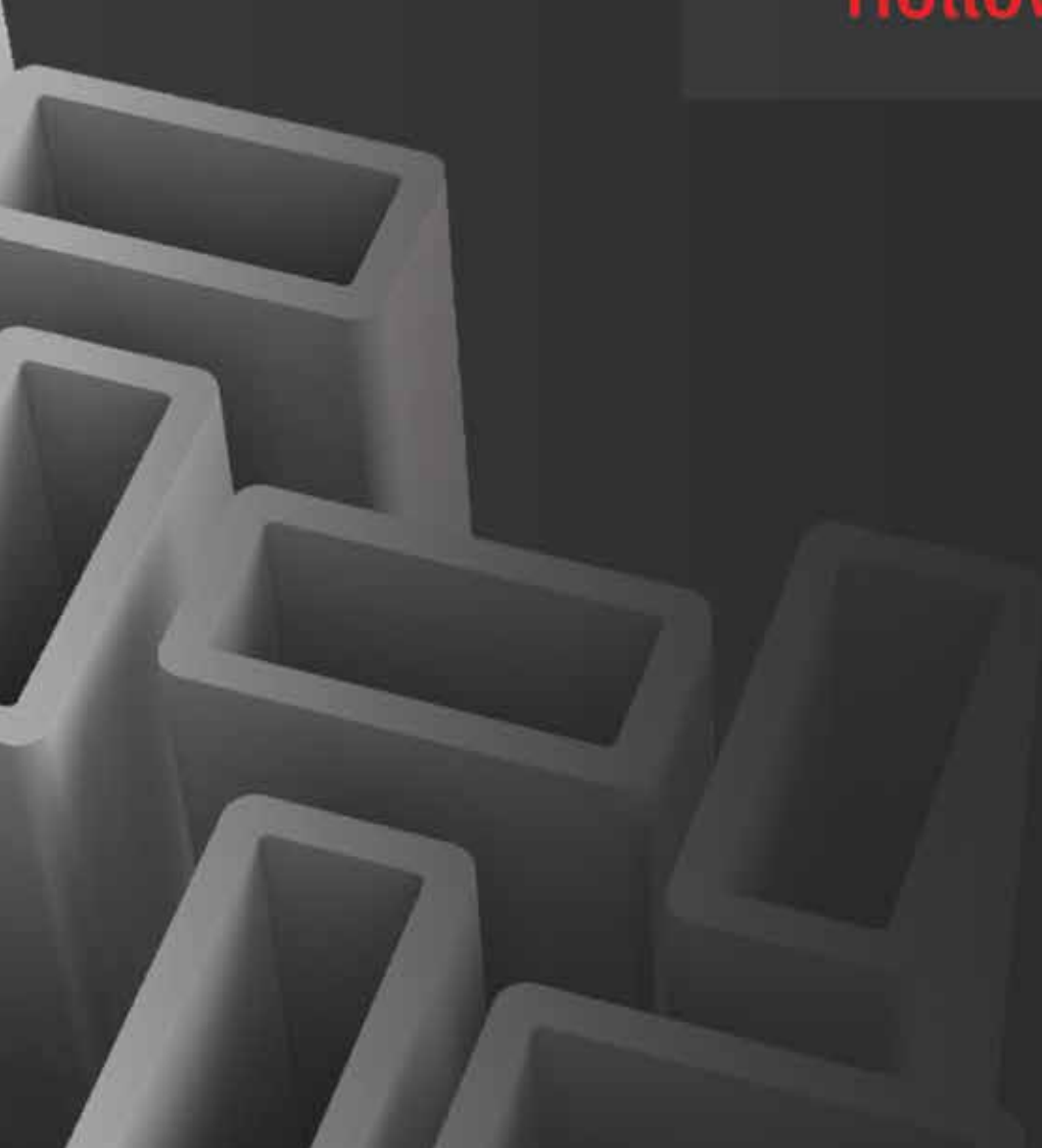

Beams - Allowable Uniform Loads

Part: 38.1 x 19.1 x 3.2mm							
Part Number: ARX-RH03801903							
			A_w	202.9mm ²	Wt.	0.6kg/m	
			I	$5.39 \times 10^4 \text{mm}^4$	S	2831mm ³	
Span (m)	Maximum Load (kN/m)		Deflection (kN/m)				
			L/100	L/150	L/180	L/240	L/360
0.5	6.24	F_b	5.45	3.64	3.03	2.27	1.51
0.8	2.44	F_b	1.38	0.92	0.76	0.57	0.38
1.1	1.29	F_b	0.54	0.36	0.30	0.22	0.15
1.4	0.80	F_b	0.26	0.17	0.14	0.11	0.07
1.7	0.54	F_b	0.15	0.10	0.08	0.06	0.04
2.0	0.39	F_b	0.09	0.06	0.05	0.04	0.02
2.3	0.29	F_b	0.06	0.04	0.03	0.02	0.02
The part weight has been deducted in the above table.							

Part: 38.1 x 25.4 x 3.2mm							
Part Number: ARX-RH03802503							
			A_w	202.9mm ²	Wt.	0.7kg/m	
			I	$6.63 \times 10^4 \text{mm}^4$	S	3478mm ³	
Span (m)	Maximum Load (kN/m)		Deflection (kN/m)				
			L/100	L/150	L/180	L/240	L/360
0.5	7.67	F_b	6.62	4.41	3.68	2.76	1.84
0.8	3.00	F_b	1.68	1.12	0.94	0.70	0.47
1.1	1.58	F_b	0.66	0.44	0.36	0.27	0.18
1.4	0.98	F_b	0.32	0.21	0.18	0.13	0.09
1.7	0.66	F_b	0.18	0.12	0.10	0.07	0.05
2.0	0.48	F_b	0.11	0.07	0.06	0.05	0.03
2.3	0.36	F_b	0.07	0.05	0.04	0.03	0.02
The part weight has been deducted in the above table.							

Part: 50.8 x 25.4 x 3.2mm

Part Number: ARX-RH05102503

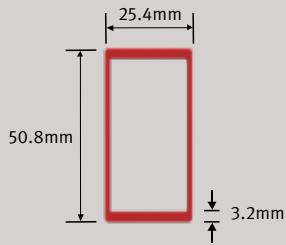

A_w	284.2mm ²	Wt.	0.8kg/m
I	1.38 x 10 ⁵ mm ⁴	S	5436mm ³

Span (m)	Maximum Load (kN/m)		Deflection (kN/m)				
			L/100	L/150	L/180	L/240	L/360
0.5	11.71	F _v	--	8.91	7.42	5.57	3.71
0.8	4.68	F _b	3.46	2.31	1.92	1.44	0.96
1.1	2.48	F _b	1.36	0.90	0.75	0.57	0.38
1.4	1.53	F _b	0.66	0.44	0.37	0.28	0.18
1.7	1.04	F _b	0.37	0.25	0.21	0.16	0.10
2.0	0.75	F _b	0.23	0.15	0.13	0.10	0.06
2.3	0.57	F _b	0.15	0.10	0.08	0.06	0.04

The part weight has been deducted in the above table.

Part: 101.6 x 25.4 x 3.2mm

Part Number: ARX-RH10202503

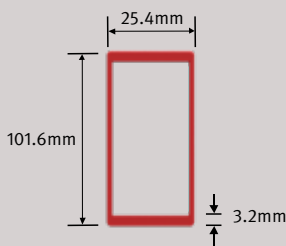

A_w	609.3mm ²	Wt.	1.4kg/m
I	8.48 x 10 ⁵ mm ⁴	S	16694mm ³

Span (m)	Maximum Load (kN/m)		Deflection (kN/m)				
			L/100	L/150	L/180	L/240	L/360
0.8	14.38	F _b	--	13.21	11.01	8.26	5.50
1.1	7.60	F _b	--	5.34	4.45	3.34	2.23
1.4	4.69	F _b	3.98	2.65	2.21	1.66	1.10
1.7	3.18	F _b	2.25	1.50	1.25	0.94	0.62
2.0	2.30	F _b	1.39	0.93	0.77	0.58	0.39
2.3	1.74	F _b	0.92	0.61	0.51	0.38	0.26
2.6	1.36	F _b	0.64	0.43	0.35	0.27	0.18
2.9	1.09	F _b	0.46	0.31	0.26	0.19	0.13
3.2	0.90	F _b	0.34	0.23	0.19	0.14	0.10

The part weight has been deducted in the above table.

Part: 101.6 x 3.2 x 50.8 x 6.4mm

Part Number: ARX-RH10205106

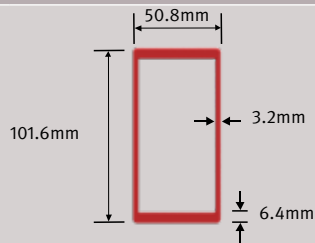

A_w	609.3mm ²	Wt.	2.2kg/m
I	1.84 x 10 ⁶ mm ⁴	S	36167mm ³

Span (m)	Maximum Load (kN/m)		Deflection (kN/m)				
			L/100	L/150	L/180	L/240	L/360
1.5	8.37	F _v	6.78	4.52	3.77	2.83	1.88
1.8	6.15	F _b	4.01	2.67	2.23	1.67	1.11
2.1	4.52	F _b	2.56	1.70	1.42	1.07	0.71
2.4	3.46	F _b	1.73	1.15	0.96	0.72	0.48
2.7	2.73	F _b	1.22	0.81	0.68	0.51	0.34
3.0	2.22	F _b	0.89	0.60	0.50	0.37	0.25
3.3	1.83	F _b	0.67	0.45	0.37	0.28	0.19
3.6	1.54	F _b	0.52	0.35	0.29	0.22	0.14

The part weight has been deducted in the above table.

Beams - Allowable Uniform Loads

Part: 111.1 x 3.2 x 34.9 x 4.8mm							
Part Number: ARX-RH1103505							
			A_w	670.3mm ²	Wt.	1.8kg/m	
			I	1.50 x 10 ⁶ mm ⁴	S	26933mm ³	
Span (m)	Maximum Load (kN/m)		Deflection (kN/m)				
			L/100	L/150	L/180	L/240	L/360
1.1	12.27	F_b	--	9.11	7.59	5.69	3.80
1.4	7.57	F_b	6.87	4.58	3.81	2.86	1.91
1.7	5.14	F_b	3.91	2.61	2.17	1.63	1.09
2.0	3.71	F_b	2.43	1.62	1.35	1.01	0.67
2.3	2.81	F_b	1.61	1.07	0.89	0.67	0.45
2.6	2.20	F_b	1.12	0.75	0.62	0.47	0.31
2.9	1.77	F_b	0.81	0.54	0.45	0.34	0.22
3.2	1.45	F_b	0.60	0.40	0.34	0.25	0.17
3.5	1.21	F_b	0.46	0.31	0.26	0.19	0.13
The part weight has been deducted in the above table.							

Part: 139.7 x 88.9 x 6.4mm							
Part Number: ARX-RH14008906							
			A_w	1624.3mm ²	Wt.	4.9kg/m	
			I	7.19 x 10 ⁶ mm ⁴	S	102947mm ³	
Span (m)	Maximum Load (kN/m)		Deflection (kN/m)				
			L/100	L/150	L/180	L/240	L/360
1.4	23.90	F_v	--	20.81	17.34	13.01	8.67
1.7	19.63	F_b	18.07	12.04	10.04	7.53	5.02
2.0	14.19	F_b	11.34	7.56	6.30	4.72	3.15
2.3	10.73	F_b	7.56	5.04	4.20	3.15	2.10
2.6	8.39	F_b	5.28	3.52	2.93	2.20	1.47
2.9	6.75	F_b	3.83	2.55	2.13	1.60	1.06
3.2	5.54	F_b	2.87	1.91	1.59	1.19	0.80
3.5	4.63	F_b	2.20	1.47	1.22	0.92	0.61
3.8	3.93	F_b	1.72	1.15	0.96	0.72	0.48
4.1	3.38	F_b	1.37	0.92	0.76	0.57	0.38
4.4	2.93	F_b	1.11	0.74	0.62	0.46	0.31
The part weight has been deducted in the above table.							

Beams - Allowable Uniform Loads

Part: 152.4 x 101.6 x 6.4mm							
Part Number: ARX-RH15210206							
			A_w	1786.9mm ²	Wt.	5.5kg/m	
			I	9.77 x 10 ⁶ mm ⁴	S	128223mm ³	
Major Axis (N/m)							
Span (m)	Maximum Load (kN/m)		Deflection (kN/m)				
			L/100	L/150	L/180	L/240	L/360
1.8	20.45	F_v	--	13.68	11.40	8.55	5.70
2.1	16.03	F_b	13.22	8.81	7.34	5.51	3.67
2.4	12.27	F_b	8.99	5.99	4.99	3.74	2.50
2.7	9.70	F_b	6.38	4.25	3.54	2.66	1.77
3.0	7.85	F_b	4.68	3.12	2.60	1.95	1.30
3.3	6.49	F_b	3.54	2.36	1.97	1.47	0.98
3.6	5.45	F_b	2.74	1.82	1.52	1.14	0.76
3.9	4.65	F_b	2.16	1.44	1.20	0.90	0.60
4.2	4.01	F_b	1.73	1.16	0.96	0.72	0.48
4.5	3.49	F_b	1.41	0.94	0.78	0.59	0.39
4.8	3.07	F_b	1.17	0.78	0.65	0.49	0.32
Minor Axis (N/m)							
A_w	993mm ²		Wt.	5.66 kg/m			
I	5032237mm ⁴		S	99141mm ³			
Span (m)	Maximum Load (N/m)		Deflection (N/m)				
			L/100	L/150	L/180	L/240	L/360
1.83	9311	F_v	----	6830	5677	4247	2817
2.13	7968	F_v	6728	4466	3707	2773	1824
2.44	6961	F_v	4612	3050	2539	1883	1240
2.74	6188	F_v	3284	2175	1795	1343	876
3.05	5560	F_v	2423	1591	1313	978	628
3.35	4801	F_b	1824	1197	992	730	467
3.66	4028	F_b	1401	919	759	555	350
3.96	3430	F_b	1095	715	584	423	263
4.27	2948	F_b	876	555	452	336	204
4.57	2554	F_b	701	452	365	263	146
4.88	2247	F_b	569	365	292	204	117
The part weight has been deducted in the above table.							

A stack of square hollow sections (SHS) is shown in the bottom-left corner of the image. The sections are arranged in a slightly irregular, overlapping manner, with some standing upright and others lying horizontally. The lighting is dramatic, highlighting the edges and the hollow interior of the sections against a dark, almost black background. The overall composition is minimalist and industrial.

Square Hollow Section

Beams - Allowable Uniform Loads

Part: 25.4 x 3.2mm							
Part Number: ARX-SH02503							
			A_w	121.6mm ²	Wt.	0.5kg/m	
			I	$2.37 \times 10^4 \text{mm}^4$	S	1867mm ³	
Span (m)	Maximum Load (kN/m)		Deflection (kN/m)				
			L/100	L/150	L/180	L/240	L/360
0.3	8.35	F_v	--	7.01	5.84	4.38	2.92
0.5	4.12	F_b	2.43	1.62	1.35	1.01	0.68
0.7	2.10	F_b	0.90	0.60	0.50	0.38	0.25
0.9	1.27	F_b	0.43	0.29	0.24	0.18	0.12
1.1	0.85	F_b	0.24	0.16	0.13	0.10	0.07
1.3	0.61	F_b	0.14	0.10	0.08	0.06	0.04
1.5	0.46	F_b	0.09	0.06	0.05	0.04	0.03
The part weight has been deducted in the above table.							

Part: 25.4 x 6.4mm							
Part Number: ARX-SH02506							
			A_w	161.3mm ²	Wt.	0.9kg/m	
			I	$3.25 \times 10^4 \text{mm}^4$	S	1867mm ³	
Span (m)	Maximum Load (kN/m)		Deflection (kN/m)				
			L/100	L/150	L/180	L/240	L/360
0.3	11.07	F_v	--	9.57	7.98	5.98	3.99
0.5	5.65	F_b	3.33	2.22	1.85	1.39	0.93
0.7	2.88	F_b	1.24	0.83	0.69	0.52	0.34
0.9	1.74	F_b	0.59	0.39	0.33	0.25	0.16
1.1	1.17	F_b	0.32	0.22	0.18	0.13	0.09
1.3	0.84	F_b	0.20	0.13	0.11	0.08	0.05
1.5	0.63	F_b	0.13	0.09	0.07	0.05	0.04
The part weight has been deducted in the above table.							

Beams - Allowable Uniform Loads

Part: 31.8 x 3.2mm							
Part Number: ARX-SH03203							
			A_w	162.6mm ²	Wt.	0.7kg/m	
			I	5.00 x 10 ⁴ mm ⁴	S	3149mm ³	
Span (m)	Maximum Load (kN/m)		Deflection (kN/m)				
			L/100	L/150	L/180	L/240	L/360
0.3	11.16	F_v	--	--	--	8.71	5.80
0.5	6.70	F_v	5.01	3.34	2.78	2.09	1.39
0.7	3.54	F_b	1.88	1.26	1.05	0.79	0.52
0.9	2.14	F_b	0.90	0.60	0.50	0.37	0.25
1.1	1.43	F_b	0.50	0.33	0.28	0.21	0.14
1.3	1.03	F_b	0.30	0.20	0.17	0.13	0.08
1.5	0.77	F_b	0.20	0.13	0.11	0.08	0.05
The part weight has been deducted in the above table.							

Part: 31.8 x 6.4mm							
Part Number: ARX-SH03206							
			A_w	243.2mm ²	Wt.	1.2kg/m	
			I	7.37 x 10 ⁴ mm ⁴	S	4643mm ³	
Span (m)	Maximum Load (kN/m)		Deflection (kN/m)				
			L/100	L/150	L/180	L/240	L/360
0.5	10.02	F_v	7.40	4.93	4.11	3.08	2.05
0.7	5.22	F_b	2.78	1.85	1.54	1.16	0.77
0.9	3.16	F_b	1.32	0.88	0.74	0.55	0.37
1.1	2.12	F_b	0.73	0.49	0.41	0.30	0.20
1.3	1.51	F_b	0.44	0.30	0.25	0.19	0.12
1.5	1.14	F_b	0.29	0.19	0.16	0.12	0.08
1.7	0.89	F_b	0.20	0.13	0.11	0.08	0.06
The part weight has been deducted in the above table.							

Beams - Allowable Uniform Loads

Part: 38.1 x 3.2mm							
Part Number: ARX-SH03803							
			A_w	202.9mm ²	Wt.	0.8kg/m	
			I	9.09 x 10 ⁴ mm ⁴	S	4772mm ³	
Span (m)	Maximum Load (kN/m)		Deflection (kN/m)				
			L/100	L/150	L/180	L/240	L/360
0.5	8.36	F_v	--	5.91	4.92	3.69	2.46
0.7	5.37	F_b	3.38	2.25	1.88	1.41	0.94
0.9	3.25	F_b	1.62	1.08	0.90	0.67	0.45
1.1	2.17	F_b	0.89	0.60	0.50	0.37	0.25
1.3	1.56	F_b	0.55	0.36	0.30	0.23	0.15
1.5	1.17	F_b	0.36	0.24	0.20	0.15	0.10
1.7	0.91	F_b	0.25	0.16	0.14	0.10	0.07
The part weight has been deducted in the above table.							

Part: 38.1 x 6.4mm							
Part Number: ARX-SH03806							
			A_w	323.8mm ²	Wt.	1.5kg/m	
			I	1.41 x 10 ⁵ mm ⁴	S	7397mm ³	
Span (m)	Maximum Load (kN/m)		Deflection (kN/m)				
			L/100	L/150	L/180	L/240	L/360
0.5	13.34	F_v	--	9.18	7.65	5.74	3.83
0.7	8.32	F_b	5.24	3.49	2.91	2.18	1.46
0.9	5.03	F_b	2.51	1.67	1.39	1.05	0.70
1.1	3.37	F_b	1.39	0.93	0.77	0.58	0.39
1.3	2.41	F_b	0.85	0.56	0.47	0.35	0.23
1.5	1.81	F_b	0.55	0.37	0.31	0.23	0.15
1.7	1.41	F_b	0.38	0.25	0.21	0.16	0.11
1.9	1.13	F_b	0.27	0.18	0.15	0.11	0.08
The part weight has been deducted in the above table.							

Beams - Allowable Uniform Loads

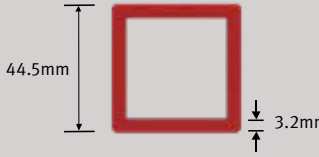
Part: 44.5 x 3.2mm							
Part Number: ARX-SH04503							
			A_w	243.8mm ²	Wt.	0.9kg/m	
			I	1.50 x 10 ⁵ mm ⁴	S	6737mm ³	
Span (m)	Maximum Load (kN/m)		Deflection (kN/m)				
			L/100	L/150	L/180	L/240	L/360
0.5	10.05	F _v	--	9.42	7.85	5.89	3.93
0.7	7.18	F _v	5.46	3.64	3.04	2.28	1.52
0.9	4.58	F _b	2.64	1.76	1.46	1.10	0.73
1.1	3.07	F _b	1.46	0.98	0.81	0.61	0.41
1.3	2.20	F _b	0.89	0.60	0.50	0.37	0.25
1.5	1.65	F _b	0.58	0.39	0.32	0.24	0.16
1.7	1.28	F _b	0.40	0.27	0.22	0.17	0.11
1.9	1.03	F _b	0.29	0.19	0.16	0.12	0.08
The part weight has been deducted in the above table.							

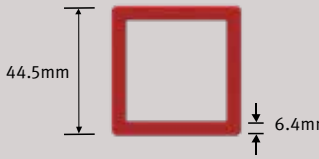
Part: 44.5 x 6.4mm							
Part Number: ARX-SH04506							
			A_w	405.8mm ²	Wt.	1.7kg/m	
			I	2.41 x 10 ⁵ mm ⁴	S	10827mm ³	
Span (m)	Maximum Load (kN/m)		Deflection (kN/m)				
			L/100	L/150	L/180	L/240	L/360
0.5	16.72	F _v	--	15.21	12.67	9.50	6.34
0.7	11.94	F _v	8.80	5.87	4.89	3.67	2.44
0.9	7.37	F _b	4.24	2.83	2.36	1.77	1.18
1.1	4.93	F _b	2.35	1.57	1.31	0.98	0.65
1.3	3.53	F _b	1.44	0.96	0.80	0.60	0.40
1.5	2.65	F _b	0.94	0.63	0.52	0.39	0.26
1.7	2.07	F _b	0.65	0.43	0.36	0.27	0.18
1.9	1.65	F _b	0.46	0.31	0.26	0.19	0.13
2.1	1.35	F _b	0.34	0.23	0.19	0.14	0.10
The part weight has been deducted in the above table.							

Beams - Allowable Uniform Loads

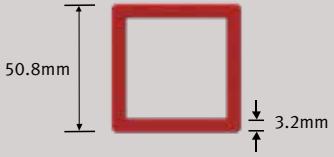
Part: 50.8 x 3.2mm							
Part Number: ARX-SH05103							
			A_w	284.2mm ²	Wt.	1.1kg/m	
			I	2.30 x 10 ⁵ mm ⁴	S	9042mm ³	
Span (m)	Maximum Load (kN/m)		Deflection (kN/m)				
			L/100	L/150	L/180	L/240	L/360
0.5	11.71	F _v	--	--	11.62	8.71	5.81
0.7	8.36	F _v	8.22	5.48	4.57	3.42	2.28
0.9	6.15	F _b	4.00	2.66	2.22	1.66	1.11
1.1	4.12	F _b	2.23	1.48	1.24	0.93	0.62
1.3	2.95	F _b	1.36	0.91	0.76	0.57	0.38
1.5	2.22	F _b	0.89	0.59	0.50	0.37	0.25
1.7	1.72	F _b	0.62	0.41	0.34	0.26	0.17
1.9	1.38	F _b	0.44	0.29	0.25	0.18	0.12
2.1	1.13	F _b	0.33	0.22	0.18	0.14	0.09
The part weight has been deducted in the above table.							

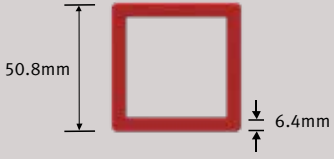
Part: 50.8 x 6.4mm							
Part Number: ARX-SH05106							
			A_w	486.4mm ²	Wt.	2.0kg/m	
			I	3.79 x 10 ⁵ mm ⁴	S	14936mm ³	
Span (m)	Maximum Load (kN/m)		Deflection (kN/m)				
			L/100	L/150	L/180	L/240	L/360
0.7	14.31	F _v	13.61	9.08	7.56	5.67	3.78
0.9	10.16	F _b	6.61	4.41	3.67	2.75	1.84
1.1	6.80	F _b	3.68	2.45	2.05	1.53	1.02
1.3	4.87	F _b	2.25	1.50	1.25	0.94	0.63
1.5	3.66	F _b	1.47	0.98	0.82	0.61	0.41
1.7	2.85	F _b	1.02	0.68	0.57	0.42	0.28
1.9	2.28	F _b	0.73	0.49	0.41	0.30	0.20
2.1	1.87	F _b	0.54	0.36	0.30	0.23	0.15
2.4	1.43	F _b	0.36	0.24	0.20	0.15	0.10
The part weight has been deducted in the above table.							

Beams - Allowable Uniform Loads

Part: 50.8 x 9.5mm							
Part Number: ARX-SH05110							
			A_w	604.2mm ²	Wt.	2.8kg/m	
			I	4.70 x 10 ⁵ mm ⁴	S	18515mm ³	
Span (m)	Maximum Load (kN/m)		Deflection (kN/m)				
			L/100	L/150	L/180	L/240	L/360
0.8	15.56	F _v	11.52	7.68	6.40	4.80	3.20
1.1	8.43	F _b	4.56	3.04	2.54	1.90	1.27
1.4	5.21	F _b	2.24	1.49	1.25	0.93	0.62
1.7	3.53	F _b	1.26	0.84	0.70	0.53	0.35
2.0	2.55	F _b	0.78	0.52	0.43	0.32	0.22
2.3	1.93	F _b	0.51	0.34	0.28	0.21	0.14
2.6	1.51	F _b	0.36	0.24	0.20	0.15	0.10
2.9	1.21	F _b	0.26	0.17	0.14	0.11	0.07
3.2	1.00	F _b	0.19	0.13	0.11	0.08	0.05
The part weight has been deducted in the above table.							

Part: 57.2 x 3.2mm							
Part Number: ARX-SH05703							
			A_w	325.1mm ²	Wt.	1.2kg/m	
			I	3.34 x 10 ⁵ mm ⁴	S	11688mm ³	
Span (m)	Maximum Load (kN/m)		Deflection (kN/m)				
			L/100	L/150	L/180	L/240	L/360
0.8	8.37	F _v	8.02	5.35	4.46	3.34	2.23
1.1	5.32	F _b	3.21	2.14	1.78	1.34	0.89
1.4	3.29	F _b	1.58	1.05	0.88	0.66	0.44
1.7	2.23	F _b	0.89	0.59	0.50	0.37	0.25
2.0	1.61	F _b	0.55	0.37	0.31	0.23	0.15
2.3	1.22	F _b	0.36	0.24	0.20	0.15	0.10
2.6	0.95	F _b	0.25	0.17	0.14	0.10	0.07
2.9	0.77	F _b	0.18	0.12	0.10	0.08	0.05
3.2	0.63	F _b	0.14	0.09	0.08	0.06	0.04
The part weight has been deducted in the above table.							

Beams - Allowable Uniform Loads

Part: 76.2 x 3.2mm

Part Number: ARX-SH07603

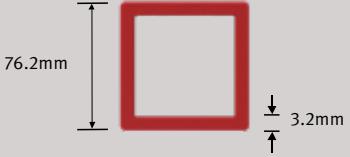

A_w	446.7mm ²	Wt.	1.7kg/m
I	8.26 x 10 ⁵ mm ⁴	S	21675mm ³

Span (m)	Maximum Load (kN/m)		Deflection (kN/m)				
			L/100	L/150	L/180	L/240	L/360
0.8	11.50	F _v	--	--	10.36	7.77	5.18
1.1	8.37	F _b	7.66	5.11	4.26	3.19	2.13
1.4	6.10	F _b	3.83	2.55	2.13	1.59	1.06
1.7	4.13	F _b	2.17	1.45	1.21	0.90	0.60
2.0	2.99	F _b	1.35	0.90	0.75	0.56	0.37
2.3	2.26	F _b	0.89	0.59	0.49	0.37	0.25
2.6	1.77	F _b	0.62	0.41	0.34	0.26	0.17
2.9	1.42	F _b	0.45	0.30	0.25	0.19	0.12
3.2	1.17	F _b	0.33	0.22	0.19	0.14	0.09

The part weight has been deducted in the above table.

Part: 76.2 x 6.4mm

Part Number: ARX-SH07606



A_w	609.3mm ²	Wt.	3.2kg/m
I	1.84 x 10 ⁶ mm ⁴	S	36167mm ³

Span (m)	Maximum Load (kN/m)		Deflection (kN/m)				
			L/100	L/150	L/180	L/240	L/360
1.2	13.93	F _v	12.77	8.51	7.09	5.32	3.55
1.5	8.37	F _b	6.78	4.52	3.77	2.83	1.88
1.8	6.15	F _b	4.01	2.67	2.23	1.67	1.11
2.1	4.52	F _b	2.56	1.70	1.42	1.07	0.71
2.4	3.46	F _b	1.73	1.15	0.96	0.72	0.48
2.7	2.73	F _b	1.22	0.81	0.68	0.51	0.34
3.0	2.22	F _b	0.89	0.60	0.50	0.37	0.25
3.3	1.83	F _b	0.67	0.45	0.37	0.28	0.19
3.6	1.54	F _b	0.52	0.35	0.29	0.22	0.14

The part weight has been deducted in the above table.

Beams - Allowable Uniform Loads

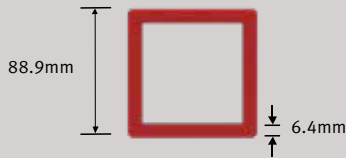
Part: 88.9 x 6.4mm							
Part Number: ARX-SH08906							
			A_w	974.1mm ²	Wt.	3.8kg/m	
			I	2.40 x 10 ⁶ mm ⁴	S	53892mm ³	
Span (m)	Maximum Load (kN/m)		Deflection (kN/m)				
			L/100	L/150	L/180	L/240	L/360
1.2	16.72	F _v	--	11.31	9.42	7.07	4.71
1.5	13.20	F _b	8.96	5.97	4.98	3.73	2.49
1.8	9.17	F _b	5.27	3.52	2.93	2.20	1.46
2.1	6.74	F _b	3.36	2.24	1.86	1.40	0.93
2.4	5.16	F _b	2.26	1.51	1.26	0.94	0.63
2.7	4.07	F _b	1.60	1.06	0.89	0.67	0.44
3.0	3.30	F _b	1.17	0.78	0.65	0.49	0.32
3.3	2.73	F _b	0.88	0.59	0.49	0.37	0.24
3.6	2.29	F _b	0.68	0.45	0.38	0.28	0.19
3.9	1.95	F _b	0.53	0.36	0.30	0.22	0.15
4.2	1.68	F _b	0.43	0.29	0.24	0.18	0.12

The part weight has been deducted in the above table.

Beams - Allowable Uniform Loads

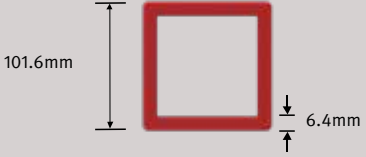
Part: 101.6 x 6.4mm							
Part Number: ARX-SH10206							
			A_w	974.1mm ²	Wt.	4.4kg/m	
			I	3.67 x 10 ⁶ mm ⁴	S	53892mm ³	
Span (m)	Maximum Load (kN/m)		Deflection (kN/m)				
			L/100	L/150	L/180	L/240	L/360
0.9	26.02	F _v	--	25.16	20.97	15.72	10.48
1.2	19.51	F _v	16.96	11.31	9.42	7.07	4.71
1.5	15.61	F _v	8.96	5.97	4.98	3.73	2.49
1.8	12.31	F _b	5.27	3.52	2.93	2.20	1.46
2.1	9.04	F _b	3.36	2.24	1.86	1.40	0.93
2.4	6.92	F _b	2.26	1.51	1.26	0.94	0.63
2.7	5.47	F _b	1.60	1.06	0.89	0.67	0.44
3.0	4.43	F _b	1.17	0.78	0.65	0.49	0.32
3.3	3.66	F _b	0.88	0.59	0.49	0.37	0.24
3.6	3.08	F _b	0.68	0.45	0.38	0.28	0.19
3.9	2.62	F _b	0.53	0.36	0.30	0.22	0.15
4.2	2.26	F _b	0.43	0.29	0.24	0.18	0.12
4.5	1.97	F _b	0.35	0.23	0.19	0.15	0.10
4.8	1.73	F _b	0.29	0.19	0.16	0.12	0.08
5.1	1.53	F _b	0.24	0.16	0.13	0.10	0.07
5.4	1.37	F _b	0.20	0.13	0.11	0.08	0.06
5.7	1.23	F _b	0.17	0.11	0.10	0.07	0.05
6.0	1.11	F _b	0.15	0.10	0.08	0.06	0.04
6.3	1.00	F _b	0.13	0.09	0.07	0.05	0.04
6.6	0.92	F _b	0.11	0.07	0.06	0.05	0.03
6.9	0.84	F _b	0.10	0.06	0.05	0.04	0.03
7.2	0.77	F _b	0.09	0.06	0.05	0.04	0.02
7.5	0.71	F _b	0.08	0.05	0.04	0.03	0.02
7.8	0.66	F _b	0.07	0.04	0.04	0.03	0.02

The part weight has been deducted in the above table.

Beams - Allowable Uniform Loads

Part: 101.6 x 8mm							
Part Number: ARX-SH10208							
			A_w	1369.6mm ²	Wt.	5.4kg/m	
			I	4.41 x 10 ⁶ mm ⁴	S	86721mm ³	
Span (m)	Maximum Load (kN/m)		Deflection (kN/m)				
			L/100	L/150	L/180	L/240	L/360
0.9	31.35	F _v	--	--	--	27.72	18.48
1.2	23.51	F _v	--	20.27	16.89	12.67	8.45
1.5	18.81	F _v	16.20	10.80	9.00	6.75	4.50
1.8	14.75	F _b	9.58	6.39	5.32	3.99	2.66
2.1	10.84	F _b	6.12	4.08	3.40	2.55	1.70
2.4	8.30	F _b	4.13	2.76	2.30	1.72	1.15
2.7	6.56	F _b	2.92	1.95	1.62	1.22	0.81
3.0	5.31	F _b	2.14	1.43	1.19	0.89	0.59
3.3	4.39	F _b	1.61	1.07	0.90	0.67	0.45
3.6	3.69	F _b	1.25	0.83	0.69	0.52	0.35
3.9	3.14	F _b	0.98	0.65	0.55	0.41	0.27
4.2	2.71	F _b	0.79	0.52	0.44	0.33	0.22
4.5	2.36	F _b	0.64	0.43	0.36	0.27	0.18
4.8	2.07	F _b	0.53	0.35	0.29	0.22	0.15
5.1	1.84	F _b	0.44	0.29	0.24	0.18	0.12
5.4	1.64	F _b	0.37	0.25	0.21	0.15	0.10
5.7	1.47	F _b	0.32	0.21	0.18	0.13	0.09
6.0	1.33	F _b	0.27	0.18	0.15	0.11	0.08
6.3	1.20	F _b	0.23	0.16	0.13	0.10	0.07
6.6	1.10	F _b	0.20	0.14	0.11	0.08	0.06
6.9	1.00	F _b	0.18	0.12	0.10	0.07	0.05
7.2	0.92	F _b	0.16	0.10	0.09	0.07	0.04
7.5	0.85	F _b	0.14	0.09	0.08	0.06	0.04
7.8	0.79	F _b	0.12	0.08	0.07	0.05	0.03

The part weight has been deducted in the above table.

Beams - Allowable Uniform Loads

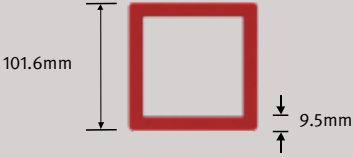
Part: 101.6 x 9.5mm							
Part Number: ARX-SH10210							
			A_w	1369.6mm ²	Wt.	6.3kg/m	
			I	5.01 x 10 ⁶ mm ⁴	S	86721mm ³	
Span (m)	Maximum Load (kN/m)		Deflection (kN/m)				
			L/100	L/150	L/180	L/240	L/360
0.9	31.35	F _v	--	--	--	27.72	18.48
1.2	23.51	F _v	--	20.27	16.89	12.67	8.45
1.5	18.81	F _v	16.20	10.80	9.00	6.75	4.50
1.8	14.75	F _b	9.58	6.39	5.32	3.99	2.66
2.1	10.84	F _b	6.12	4.08	3.40	2.55	1.70
2.4	8.30	F _b	4.13	2.76	2.30	1.72	1.15
2.7	6.56	F _b	2.92	1.95	1.62	1.22	0.81
3.0	5.31	F _b	2.14	1.43	1.19	0.89	0.59
3.3	4.39	F _b	1.61	1.07	0.90	0.67	0.45
3.6	3.69	F _b	1.25	0.83	0.69	0.52	0.35
3.9	3.14	F _b	0.98	0.65	0.55	0.41	0.27
4.2	2.71	F _b	0.79	0.52	0.44	0.33	0.22
4.5	2.36	F _b	0.64	0.43	0.36	0.27	0.18
4.8	2.07	F _b	0.53	0.35	0.29	0.22	0.15
5.1	1.84	F _b	0.44	0.29	0.24	0.18	0.12
5.4	1.64	F _b	0.37	0.25	0.21	0.15	0.10
5.7	1.47	F _b	0.32	0.21	0.18	0.13	0.09
6.0	1.33	F _b	0.27	0.18	0.15	0.11	0.08
6.3	1.20	F _b	0.23	0.16	0.13	0.10	0.07
6.6	1.10	F _b	0.20	0.14	0.11	0.08	0.06
6.9	1.00	F _b	0.18	0.12	0.10	0.07	0.05
7.2	0.92	F _b	0.16	0.10	0.09	0.07	0.04
7.5	0.85	F _b	0.14	0.09	0.08	0.06	0.04
7.8	0.79	F _b	0.12	0.08	0.07	0.05	0.03

The part weight has been deducted in the above table.

Beams - Allowable Uniform Loads

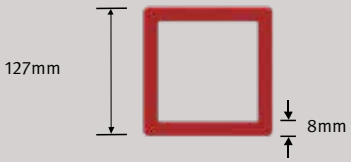
Part: 127 x 8mm							
Part Number: ARX-SH12708							
			A_w	1776.0mm ²	Wt.	6.9kg/m	
			I	9.03 x 10 ⁶ mm ⁴	S	142175mm ³	
Span (m)	Maximum Load (kN/m)		Deflection (kN/m)				
			L/100	L/150	L/180	L/240	L/360
0.9	40.65	F _v	--	--	--	--	34.35
1.2	30.49	F _v	--	--	--	24.44	16.29
1.5	24.39	F _v	--	21.24	17.70	13.28	8.85
1.8	20.33	F _v	19.07	12.72	10.60	7.95	5.30
2.1	17.42	F _v	12.27	8.18	6.81	5.11	3.41
2.4	13.61	F _b	8.33	5.55	4.63	3.47	2.31
2.7	10.75	F _b	5.91	3.94	3.28	2.46	1.64
3.0	8.71	F _b	4.34	2.89	2.41	1.81	1.20
3.3	7.20	F _b	3.27	2.18	1.82	1.36	0.91
3.6	6.05	F _b	2.53	1.69	1.41	1.06	0.70
3.9	5.15	F _b	2.00	1.33	1.11	0.83	0.55
4.2	4.44	F _b	1.60	1.07	0.89	0.67	0.45
4.5	3.87	F _b	1.31	0.87	0.73	0.54	0.36
4.8	3.40	F _b	1.08	0.72	0.60	0.45	0.30
5.1	3.01	F _b	0.90	0.60	0.50	0.38	0.25
5.4	2.69	F _b	0.76	0.51	0.42	0.32	0.21
5.7	2.41	F _b	0.65	0.43	0.36	0.27	0.18
6.0	2.18	F _b	0.55	0.37	0.31	0.23	0.15
6.3	1.97	F _b	0.48	0.32	0.27	0.20	0.13
6.6	1.80	F _b	0.42	0.28	0.23	0.17	0.12
6.9	1.65	F _b	0.37	0.24	0.20	0.15	0.10
7.2	1.51	F _b	0.32	0.21	0.18	0.13	0.09
7.5	1.39	F _b	0.28	0.19	0.16	0.12	0.08
7.8	1.29	F _b	0.25	0.17	0.14	0.11	0.07

The part weight has been deducted in the above table.

Beams - Allowable Uniform Loads

Part: 152.4 x 9.5mm							
Part Number: ARX-SH15210							
			A_w	2534.6mm ²	Wt.	9.8kg/m	
			I	1.86 x 10 ⁷ mm ⁴	S	244125mm ³	
Span (m)	Maximum Load (kN/m)		Deflection (kN/m)				
			L/100	L/150	L/180	L/240	L/360
0.9	58.01	F _v	--	--	--	--	--
1.2	43.51	F _v	--	--	--	--	31.35
1.5	34.81	F _v	--	--	34.80	26.10	17.40
1.8	29.01	F _v	--	25.33	21.10	15.83	10.55
2.1	24.86	F _v	24.63	16.42	13.69	10.26	6.84
2.4	21.76	F _b	16.83	11.22	9.35	7.01	4.67
2.7	18.46	F _b	11.98	7.99	6.66	4.99	3.33
3.0	14.95	F _b	8.82	5.88	4.90	3.67	2.45
3.3	12.36	F _b	6.67	4.45	3.71	2.78	1.85
3.6	10.38	F _b	5.17	3.45	2.87	2.15	1.44
3.9	8.85	F _b	4.08	2.72	2.27	1.70	1.13
4.2	7.63	F _b	3.28	2.19	1.82	1.37	0.91
4.5	6.65	F _b	2.68	1.78	1.49	1.11	0.74
4.8	5.84	F _b	2.21	1.47	1.23	0.92	0.61
5.1	5.17	F _b	1.85	1.23	1.03	0.77	0.51
5.4	4.61	F _b	1.56	1.04	0.87	0.65	0.43
5.7	4.14	F _b	1.33	0.88	0.74	0.55	0.37
6.0	3.74	F _b	1.14	0.76	0.63	0.47	0.32
6.3	3.39	F _b	0.98	0.66	0.55	0.41	0.27
6.6	3.09	F _b	0.86	0.57	0.48	0.36	0.24
6.9	2.83	F _b	0.75	0.50	0.42	0.31	0.21
7.2	2.60	F _b	0.66	0.44	0.37	0.28	0.18
7.5	2.39	F _b	0.59	0.39	0.33	0.24	0.16
7.8	2.21	F _b	0.52	0.35	0.29	0.22	0.14

The part weight has been deducted in the above table.

Interlocking Deckboard

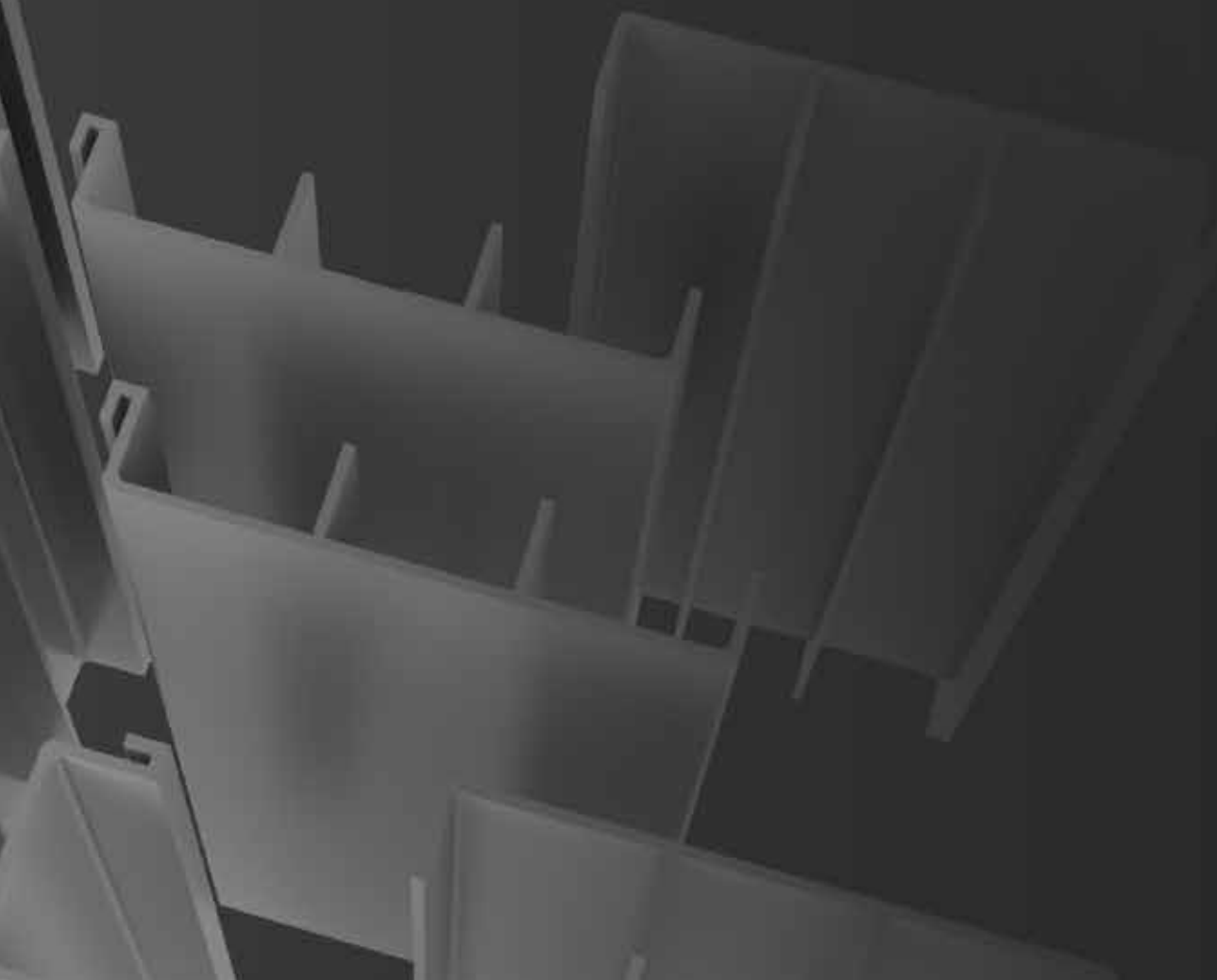

Part: SureLine® Standard Panel

Part Number: ARX-SL054

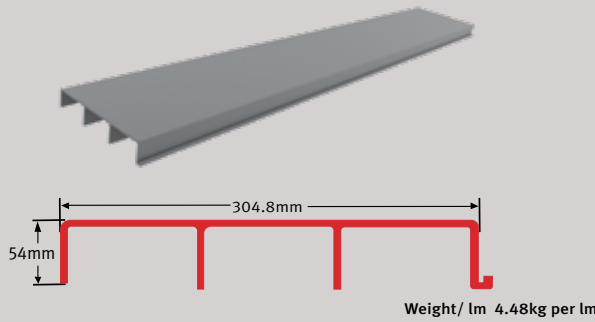

A_w	1036 mm ²	W_t	4.48 kg/m
I	765865mm ⁴	S	14798 mm ³

Span (mm)	Maximum Load (kPa)	Deflection (kPa)									
		L/D=120	L/D=150	L/D=180	L/D=220	L/D=250	L/D=300	L/D=350	L/D=400	L/D=500	
400	99.98									80.79	
600	44.44							38.27	33.49	26.79	
800	25.00					23.59	19.66	16.85	14.74	11.79	
1000	16.00				14.00	12.32	10.27	8.80	7.70	6.16	
1200	11.11			10.02	8.20	7.21	6.01	5.15	4.51	3.61	
1400	8.16		7.62	6.35	5.20	4.57	3.81	3.27	2.86	2.29	
1600	6.25		5.13	4.27	3.50	3.08	2.56	2.20	1.92	1.54	
1800	4.94	4.52	3.61	3.01	2.46	2.17	1.81	1.55	1.35	1.08	
2000	4.00	3.30	2.64	2.20	1.80	1.58	1.32	1.13	0.99	0.79	
2200	3.31	2.48	1.99	1.66	1.35	1.19	0.99	0.85	0.74	0.60	
2400	2.78	1.92	1.53	1.28	1.04	0.92	0.77	0.66	0.57	0.46	
2600	2.37	1.51	1.21	1.01	0.82	0.72	0.60	0.52	0.45	0.36	
2800	2.04	1.21	0.97	0.81	0.66	0.58	0.48	0.41	0.36	0.29	
3000	1.78	0.98	0.79	0.66	0.54	0.47	0.39	0.34	0.29	0.24	
3200	1.56	0.81	0.65	0.54	0.44	0.39	0.32	0.28	0.24	0.19	

Installation

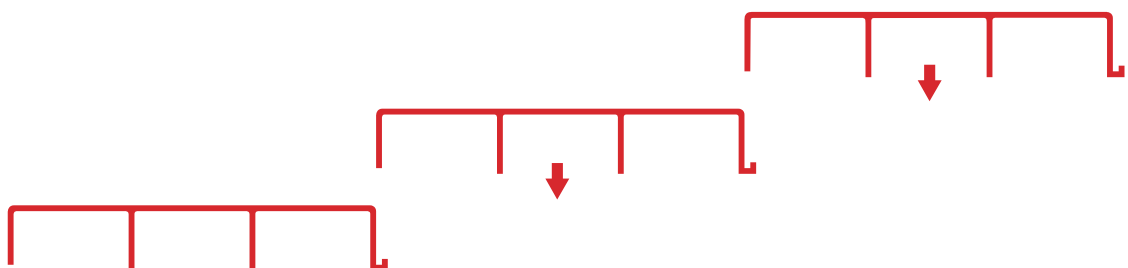

SureLine® Medium Duty Panel

Part: SureLine® Medium Duty Panel

Part Number: ARX-SL040

	A_w	2200 mm ²	W_t	10.8 kg/m
	I	1021011 mm ⁴	S	39930 mm ³

Span (mm)	Maximum Load (kPa)	Deflection (kPa)									
		L/D=100	L/D=120	L/D=150	L/D=180	L/D=220	L/D=250	L/D=300	L/D=350	L/D=400	L/D=500
400	226.60					196.78	173.17	144.31	123.69	108.23	86.59
600	122.33	140.68	117.23	93.78	78.15	63.94	56.27	46.89	40.19	35.17	28.14
800	68.81	61.43	51.19	40.95	34.13	27.92	24.57	20.48	17.55	15.36	12.29
1000	44.04	31.97	26.64	21.31	17.76	14.53	12.79	10.66	9.13	7.99	6.39
1200	30.58	18.67	15.56	12.45	10.37	8.49	7.47	6.22	5.33	4.67	3.73
1400	22.47	11.82	9.85	7.88	6.57	5.37	4.73	3.94	3.38	2.96	2.36
1600	17.20	7.95	6.62	5.30	4.41	3.61	3.18	2.65	2.27	1.99	1.59
1800	13.59	5.59	4.66	3.73	3.11	2.54	2.24	1.86	1.60	1.40	1.12
2000	11.01	4.09	3.40	2.72	2.27	1.86	1.63	1.36	1.17	1.02	0.82
2200	9.10	3.07	2.56	2.05	1.71	1.40	1.23	1.02	0.88	0.77	0.61
2400	7.65	2.37	1.97	1.58	1.32	1.08	0.95	0.79	0.68	0.59	0.47
2600	6.51	1.87	1.55	1.24	1.04	0.85	0.75	0.62	0.53	0.47	0.37
2800	5.62	1.49	1.25	1.00	0.83	0.68	0.60	0.50	0.43	0.37	0.30
3000	4.89	1.22	1.01	0.81	0.68	0.55	0.49	0.41	0.35	0.30	0.24
3200	4.30	1.00	0.84	0.67	0.56	0.46	0.40	0.33	0.29	0.25	0.20

Installation



Part: SureLine® Heavy Duty Panel

Part Number: ARX-SL100

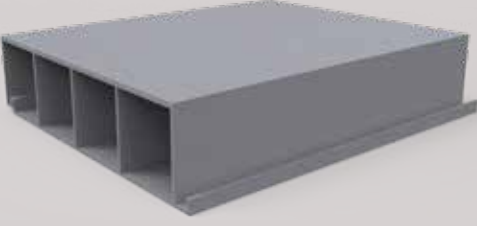
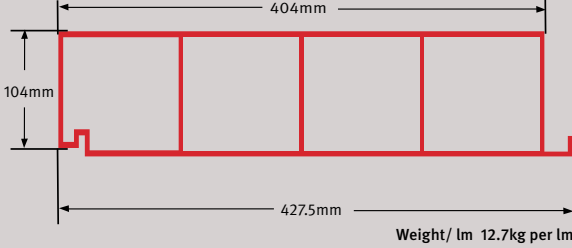
A_w	2080 mm ²	W_t	12.7 kg/m
I	11096613 mm ⁴	S	192449 mm ³

Span (mm)	Maximum Load (kPa)	Deflection (kPa)									
		L/D=100	L/D=120	L/D=150	L/D=180	L/D=220	L/D=250	L/D=300	L/D=350	L/D=400	L/D=500
1000	106.06							105.70	90.60	79.28	63.42
1200	88.38						79.43	66.19	56.74	49.65	39.72
1400	75.76				73.09	59.80	52.63	43.86	37.59	32.89	26.31
1600	66.29			60.82	50.68	41.47	36.49	30.41	26.06	22.81	18.25
1800	58.92		54.71	43.76	36.47	29.84	26.26	21.88	18.76	16.41	13.13
2000	53.03	48.71	40.59	32.47	27.06	22.14	19.48	16.24	13.92	12.18	9.74
2200	48.21	37.09	30.91	24.73	20.61	16.86	14.84	12.36	10.60	9.27	7.42
2400	44.19	28.86	24.05	19.24	16.04	13.12	11.55	9.62	8.25	7.22	5.77
2600	38.86	22.89	19.07	15.26	12.71	10.40	9.15	7.63	6.54	5.72	4.58
2800	33.51	18.44	15.37	12.29	10.25	8.38	7.38	6.15	5.27	4.61	3.69
3000	29.19	15.07	12.56	10.05	8.37	6.85	6.03	5.02	4.31	3.77	3.01
3200	25.65	12.47	10.39	8.32	6.93	5.67	4.99	4.16	3.56	3.12	2.49
3400	22.72	10.44	8.70	6.96	5.80	4.74	4.17	3.48	2.98	2.61	2.09
3600	20.27	8.82	7.35	5.88	4.90	4.01	3.53	2.94	2.52	2.20	1.76
3800	18.19	7.52	6.26	5.01	4.18	3.42	3.01	2.51	2.15	1.88	1.50
4000	16.42	6.46	5.38	4.31	3.59	2.94	2.58	2.15	1.85	1.61	1.29
4200	14.89	5.59	4.66	3.73	3.11	2.54	2.24	1.86	1.60	1.40	1.12
4400	13.57	4.87	4.06	3.25	2.71	2.21	1.95	1.62	1.39	1.22	0.97
4600	12.41	4.27	3.56	2.85	2.37	1.94	1.71	1.42	1.22	1.07	0.85

Installation

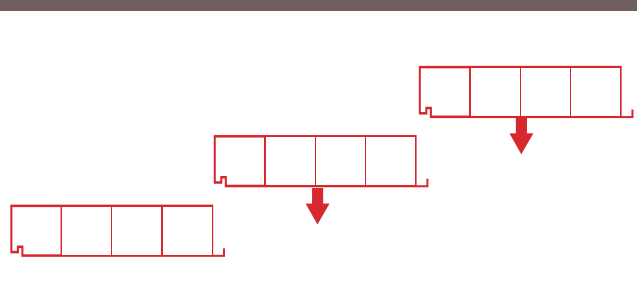

Unique Panel Removal Feature

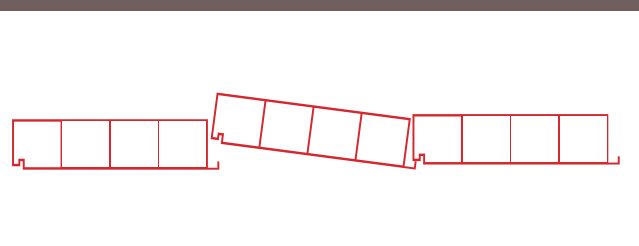

This allows access to a central panel without having to remove all panels.

Part: UnidEX®40mm thick decking, 120mm bar width and 6mm gap

Part Number: **ARX-UN04012006**

Properties per Bar

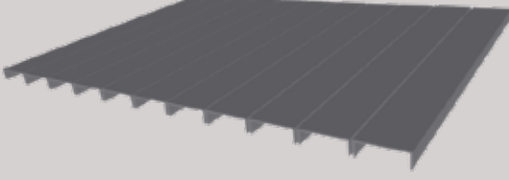
	A_w	400mm ²	W_t	17 kg/m
	I	125400mm ⁴	S	4716mm ³



Span (mm)	Maximum Load (KPa)	Deflection (kPa)									
		L/D=100	L/D=120	L/D=150	L/D=180	L/D=220	L/D=250	L/D=300	L/D=350	L/D=400	L/D=500
400	44.59										42.60
600	19.82								19.19	16.79	13.43
800	11.15							9.66	8.28	7.24	5.80
1000	7.13					6.82	6.00	5.00	4.28	3.75	3.00
1200	4.95				4.85	3.97	3.49	2.91	2.49	2.18	1.75
1400	3.64				3.06	2.51	2.21	1.84	1.58	1.38	1.10
1600	2.79			2.47	2.06	1.68	1.48	1.23	1.06	0.93	0.74
1800	2.20		2.17	1.74	1.45	1.18	1.04	0.87	0.74	0.65	0.52
2000	1.78	1.90	1.58	1.27	1.06	0.86	0.76	0.63	0.54	0.48	0.38

TreadSLAB®

TreadSLAB® is an immensely versatile profile which combines lightweight and inherent strength to provide a durable product with a variety of surface textures and a customisable range of colours. Through the selection of the appropriate resin system, the user can create components that will meet the most demanding of specifications.

Pultruded through a die, TreadSLAB® outperforms with an impressive strength to weight ratio to produce a composite flooring structure that is strong, durable, corrosion resistant and boasts low maintenance on an anti-slip surface.

Benefits

- High strength
- Light weight
- Dimensional stability
- Corrosion, chemical, electrical resistance
- Low tooling/installation cost
- Long life
- Favourable performance/lifecycle cost basis versus traditional materials

TreadSLAB® easily outperforms traditional materials in terms of performance/ lifecycle costs.

TreadSLAB® 45

Part: TreadSLAB® 45mm Thick Decking, 48mm Web Distance, 4.5mm Flange Thickness and 3.5mm Web Thickness

Part Number: ARX-TS04504805

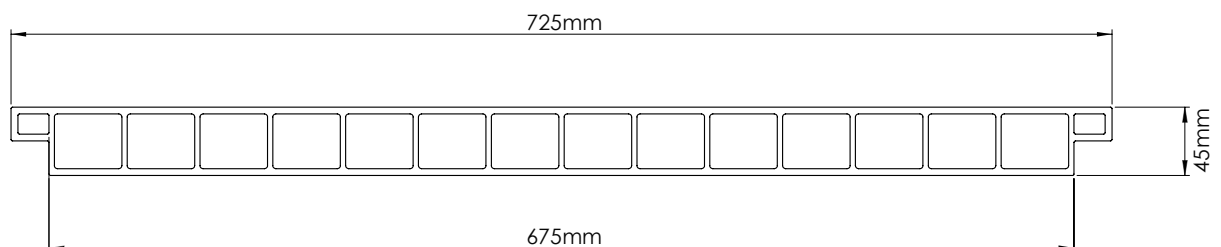

Panel Size (mm)			Surface Type	Weight Per Square Metre (kg/m ²)
Thickness	Standard Length	Width		
45mm Top	3660	725	Top Grit	25
45mm Bottom	3660	675	Bottom Grit	

TreadSLAB® 50

Part: TreadSLAB® 50mm Thick Decking, 55mm Web Distance, 6mm Flange Thickness and 9mm Web Thickness

Part Number: ARX-TS05005506

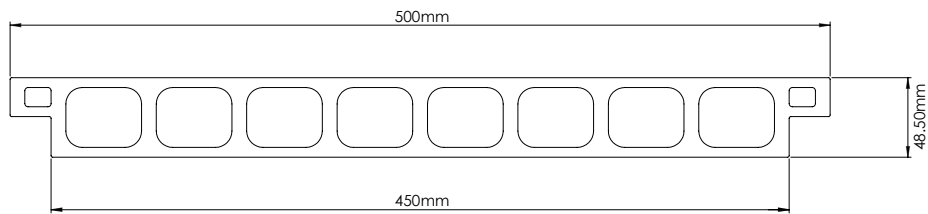
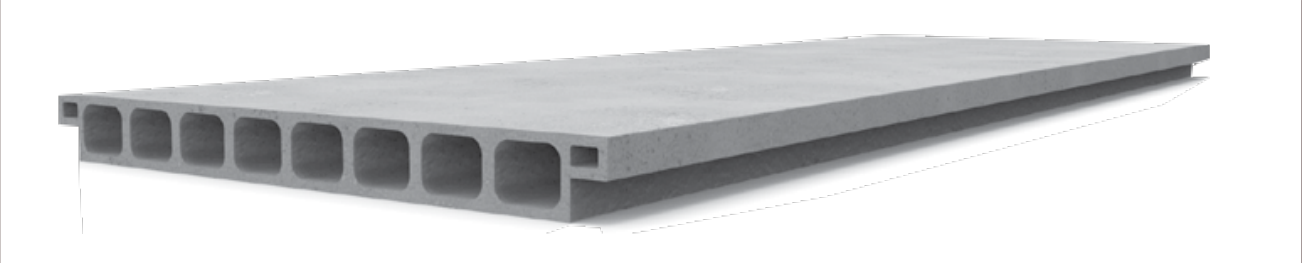

Panel Size (mm)			Surface Type	Weight Per Square Metre (kg/m ²)
Thickness	Standard Length	Width		
50mm Top	3660	500	Top Grit	36.44
50mm Bottom	3660	450	Bottom Grit	

TreadSLAB® 100

Part: TreadSLAB® 100mm Thick Decking, 60mm Web Distance, 13mm Flange Thickness and 12mm Web Thickness

Part Number: ARX-TS10006013

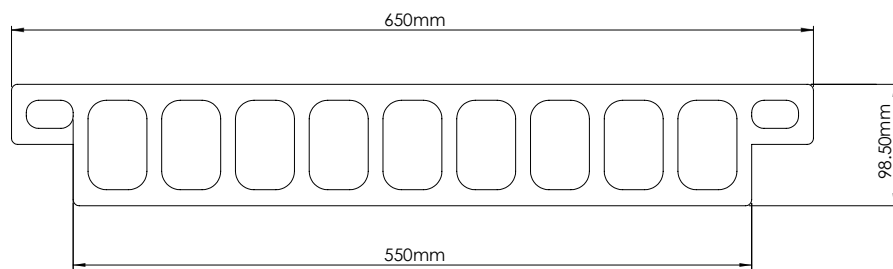

Panel Size (mm)			Surface Type	Weight Per Square Metre (kg/m ²)
Thickness	Standard Length	Width		
100mm Top	3660	650	Top Grit	92.17
100mm Bottom	3660	550	Bottom Grit	

Part: TreadSLAB® 47.5mm Thick Decking, 74.6mm Web Distance and 6.4mm Thickness

Part Number: ARX-TS04807506

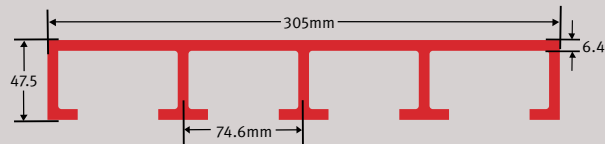

Part: TreadSLAB® 54mm Thick Decking, 100mm Web Distance and 5mm Thickness

Part Number: ARX-TS05410005

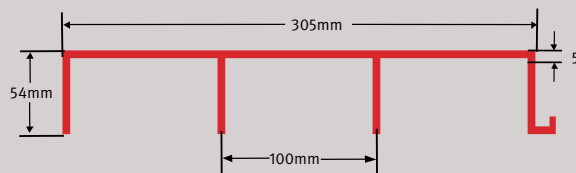

Part: TreadSLAB® 83mm Thick Decking, 49.7mm Web Distance and 6.4mm Thickness

Part Number: ARX-TS08305006

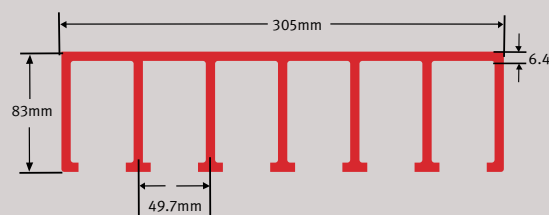

A stack of several white sheets of paper is shown in the bottom-left corner of the image, fanned out slightly. The rest of the image is a dark, almost black, gradient background. In the center-right area, there is a semi-transparent dark grey rectangular box containing the text "Flat Sheet" in a bright red, sans-serif font.

Flat Sheet

Part: 3.2mm Flat Sheet								
Part Number: ARX-FP03								
SPAN Lengthwise direction of the Flat Sheet								Wt. 6.1kg/m ²
For span in the crosswise direction of the Flat Sheet multiply load by 0.70								
Maximum loads shown are for deflections of t/2								
Span (m)	Deflection (mm)							
0.15	Load (kPa) or (kN/m)	0.8	1	2	5	7	9	14
	U	0.14	0.18	0.35	0.88	1.23	1.58	2.37
	C	1.49	----	----	----	----	----	----
0.25	Load (kPa) or (kN/m)	0.15	0.2	0.5	0.8	1.1	1.0	1.1
	U	0.2	0.27	0.68	1.08	1.49	2.76	2.97
	C	1.3	----	----	----	----	----	----
0.35	Load (kPa) or (kN/m)	0.1	0.2	0.3	----	----	----	----
	U	0.52	1.04	1.56	----	----	----	----
	C	----	----	----	----	----	----	----
LOAD kPa for Uniform Load or kN/m for Concentrated Line Load								
U mm. Deflection for Uniform Load								
C mm. Deflection for Concentrated Line Load								

Flat Sheet

Part: 6.4mm Thickness								
Part Number: ARX-FP06								
SPAN Lengthwise direction of the Flat Sheet								Wt. 12.2 kg/m ²
For span in the crosswise direction of the Flat Sheet multiply load by 0.70								
Maximum loads shown are for deflections of t/2								
Span (m)	Deflection (mm)							
0.25	Load (kPa) or (kN/m)	1	2	4	6	8	12	14
	U	0.17	0.34	0.68	1.01	1.35	2.03	2.37
	C	0.11	2.16	----	----	----	----	----
0.5	Load (kPa) or (kN/m)	0.2	0.3	0.4	0.5	0.75	1.0	1.1
	U	0.55	0.83	1.1	1.38	2.07	2.76	2.97
	C	1.78	2.68	----	----	----	----	----
0.75	Load (kPa) or (kN/m)	0.1	0.15	0.2	----	----	----	----
	U	1.40	2.05	2.73	----	----	----	----
	C	2.92	----	----	----	----	----	----
LOAD kPa for Uniform Load or kN/m for Concentrated Line Load								
U mm. Deflection for Uniform Load								
C mm. Deflection for Concentrated Line Load								

Part: 9.5mm Thickness											
Part Number: ARX-FP10											
SPAN Lengthwise direction of the Flat Sheet											Wt. 18.0 kg/m ²
For span in the crosswise direction of the Flat Sheet multiply load by 0.70											
Maximum loads shown are for deflections of t/2											
Span (m)	Deflection (mm)										
	Load (kPa) or (kN/m)	1	5	10	15	20	25	30	35	40	45
0.25	U	0.05	0.26	0.52	0.78	1.03	1.29	1.55	1.81	2.07	2.33
	C	0.33	1.66	3.31	----	----	----	----	----	----	----
0.5	U	0.17	0.41	0.83	1.24	1.65	2.48	3.3	4.13	4.54	----
	C	0.53	1.32	2.64	3.97	----	----	----	----	----	----
0.75	U	0.42	0.84	1.67	2.09	2.51	3.34	4.18	----	----	----
	C	0.89	1.78	3.57	4.46	----	----	----	----	----	----
1	U	1.32	2.64	3.3	4.62	----	----	----	----	----	----
	C	2.11	4.23	----	----	----	----	----	----	----	----
1.25	U	1.61	3.22	4.51	----	----	----	----	----	----	----
	C	2.06	4.13	----	----	----	----	----	----	----	----

LOAD kPa for Uniform Load or kN/m for Concentrated Line Load

U mm. Deflection for Uniform Load

C mm. Deflection for Concentrated Line Load

Flat Sheet

Part: 12.7mm Thickness												
Part Number: ARX-FP13												
SPAN Lengthwise direction of the Flat Sheet												Wt. 24.1 kg/m ²
For span in the crosswise direction of the Flat Sheet multiply load by 0.70												
Maximum loads shown are for deflections of t/2												
Span (m)	Deflection (mm)											
	Load (kPa) or (kN/m)	1	5	10	20	40	50	60	70	80	90	100
0.25	U	0.02	0.11	0.22	0.43	0.86	1.08	1.29	1.51	1.73	1.94	2.17
	C	0.14	0.70	1.39	2.79	----	----	----	----	----	----	----
	Load (kPa) or (kN/m)	1	2	4	4.5	6	7	8	9	10	12	14
0.5	U	0.35	0.69	1.38	1.55	2.07	2.42	2.76	3.11	3.45	4.14	4.84
	C	1.12	2.23	4.46	5.02	----	----	----	----	----	----	----
	Load (kPa) or (kN/m)	0.5	1	1.5	1.7	2	2.5	3	3.5	----	----	----
0.75	U	0.87	1.75	2.62	2.97	3.49	4.37	5.24	6.12	----	----	----
	C	1.88	3.76	5.65	6.40	----	----	----	----	----	----	----
	Load (kPa) or (kN/m)	0.2	0.3	0.5	0.7	0.8	0.9	1	1.1	----	----	----
1	U	1.10	1.66	2.76	3.87	4.42	4.97	5.52	6.07	----	----	----
	C	1.78	2.68	4.46	6.19	----	----	----	----	----	----	----
	Load (kPa) or (kN/m)	0.05	0.1	0.2	0.3	0.35	0.4	0.45	----	----	----	----
1.25	U	0.67	1.35	2.70	4.04	4.99	5.39	6.07	----	----	----	----
	C	0.87	1.74	3.48	5.23	6.05	----	----	----	----	----	----
	Load (kPa) or (kN/m)	0.05	0.1	0.2	0.3	0.35	0.4	0.45	----	----	----	----

LOAD kPa for Uniform Load or kN/m for Concentrated Line Load

U mm. Deflection for Uniform Load

C mm. Deflection for Concentrated Line Load

Part: 15.9mm Thickness												
Part Number: ARX-FP16												
SPAN Lengthwise direction of the Flat Sheet												Wt. 30.2 kg/m ²
For span in the crosswise direction of the Flat Sheet multiply load by 0.70												
Maximum loads shown are for deflections of the lesser of t/2												
Span (m)	Deflection (mm)											
	Load (kPa) or (kN/m)	1	5	10	20	40	50	75	100	125	150	200
0.25	U	0.01	0.06	0.11	0.22	0.44	0.55	0.83	1.11	1.39	1.66	2.22
	C	0.07	0.36	0.71	1.42	2.85	----	----	----	----	----	----
	Load (kPa) or (kN/m)	1	2	4	6	9	10	15	20	25	28	----
0.5	U	0.18	0.35	0.71	1.06	5.08	1.77	2.65	3.53	4.42	4.95	----
	C	0.57	1.14	2.28	3.43	5.08	----	----	----	----	----	----
	Load (kPa) or (kN/m)	1	2	3	4	5	6	7	8	8.5	----	----
0.75	U	0.89	1.79	2.68	3.57	4.47	5.37	6.26	7.14	7.58	----	----
	C	1.93	3.85	5.78	7.61	----	----	----	----	----	----	----
	Load (kPa) or (kN/m)	0.5	0.6	0.8	1	1.5	1.7	2	2.5	2.8	----	----
1	U	1.41	1.70	2.26	2.83	4.24	4.79	5.66	7.07	7.89	----	----
	C	2.28	2.74	3.65	4.57	6.85	7.67	----	----	----	----	----
	Load (kPa) or (kN/m)	0.2	0.4	0.6	0.8	0.9	1	1.1	----	----	----	----
1.25	U	1.38	2.76	4.14	5.52	6.19	6.9	7.59	----	----	----	----
	C	1.78	3.57	5.35	7.14	7.93	----	----	----	----	----	----
	Load (kPa) or (kN/m)	0.2	0.3	0.4	0.5	----	----	----	----	----	----	----
1.5	U	2.86	4.29	5.73	7.16	----	----	----	----	----	----	----
	C	3.08	4.62	6.17	7.71	----	----	----	----	----	----	----
	Load (kPa) or (kN/m)	0.2	0.3	----	----	----	----	----	----	----	----	----
1.75	U	5.30	7.96	----	----	----	----	----	----	----	----	----
	C	4.90	7.34	----	----	----	----	----	----	----	----	----
	Load (kPa) or (kN/m)	0.2	0.3	----	----	----	----	----	----	----	----	----

LOAD kPa for Uniform Load or kN/m for Concentrated Line Load

U mm. Deflection for Uniform Load

C mm. Deflection for Concentrated Line Load

Flat Sheet

Part: 19.0mm Thickness											
Part Number: ARX-FP19											
SPAN Lengthwise direction of the Flat Sheet											Wt. 36.1 kg/m ²
For span in the crosswise direction of the Flat Sheet multiply load by 0.70											
Maximum loads shown are for deflections of the lesser of t/2											
Span (m)	Deflection (mm)										
0.25	Load (kPa) or (kN/m)	5	10	20	30	40	50	60	100	200	300
	U	0.03	0.06	0.13	0.19	0.26	0.32	0.39	0.64	1.3	1.96
	C	0.21	0.41	0.83	1.24	1.65	2.07	2.51	----	----	----
0.5	Load (kPa) or (kN/m)	1	2	5	8	10	12	15	20	25	30
	U	0.1	0.2	0.51	0.82	1.02	1.23	1.53	2.05	2.56	3.07
	C	0.33	0.66	1.65	2.64	3.30	3.97	4.96	----	----	----
0.75	Load (kPa) or (kN/m)	1	2	3	4	5	6	6.5	8	10	15
	U	0.52	1.04	1.55	2.07	2.59	3.11	3.4	4.14	5.18	7.84
	C	1.12	2.23	3.35	4.46	5.58	6.69	7.25	----	----	----
1	Load (kPa) or (kN/m)	1	2	2.5	3	3.5	4	4.5	5	5.5	----
	U	1.64	3.27	4.09	4.91	5.78	6.55	7.36	8.18	9.09	----
	C	2.64	5.29	6.61	7.93	9.25	----	----	----	----	----
1.25	Load (kPa) or (kN/m)	1	1.2	1.5	1.8	2	2.3	----	----	----	----
	U	3.99	4.79	5.99	7.26	7.99	9.27	----	----	----	----
	C	5.16	6.20	7.74	9.29	----	----	----	----	----	----
1.5	Load (kPa) or (kN/m)	0.4	0.6	0.7	0.8	0.9	1	1.1	----	----	----
	U	3.31	4.97	5.80	6.63	7.46	8.28	9.20	----	----	----
	C	3.57	5.35	6.24	7.14	8.03	8.92	----	----	----	----
LOAD kPa for Uniform Load or kN/m for Concentrated Line Load											
U mm. Deflection for Uniform Load											
C mm. Deflection for Concentrated Line Load											

Part: 25.4mm Thickness												
Part Number: ARX-FP25												
SPAN Lengthwise direction of the Flat Sheet												Wt. 48.3 kg/m ²
For span in the crosswise direction of the Flat Sheet multiply load by 0.70												
Maximum loads shown are for deflections of the lesser of t/2												
Span (m)	Deflection (mm)											
0.5	Load (kPa) or (kN/m)	5	10	15	20	25	30	35	50	75	100	115
	U	0.22	0.43	0.65	0.86	1.08	1.29	1.52	2.16	3.24	4.31	5.00
	C	0.70	1.39	2.09	2.79	3.48	4.18	4.87	----	----	----	---
0.75	Load (kPa) or (kN/m)	1	5	7.5	10	15	16	20	25	30	34	----
	U	0.22	1.09	1.64	2.18	3.28	3.49	4.37	5.46	6.55	7.45	----
	C	0.47	2.35	3.53	4.70	7.06	7.48	----	----	----	----	----
1	Load (kPa) or (kN/m)	1	2	5	7.5	9	10	12	14	----	----	----
	U	0.69	1.38	3.45	5.18	6.21	6.90	8.28	9.66	----	----	----
	C	1.12	2.23	5.58	8.36	9.97	----	----	----	----	----	----
1.25	Load (kPa) or (kN/m)	1	2	3	4	5	6	7	7.4	----	----	----
	U	1.69	3.37	5.06	6.74	8.43	10.11	11.80	12.49	----	----	----
	C	2.18	4.36	6.53	8.71	10.89	----	----	----	----	----	----
1.5	Load (kPa) or (kN/m)	1	2	3	3.4	3.6	----	----	----	----	----	----
	U	3.49	6.99	10.48	11.88	12.58	----	----	----	----	----	----
	C	3.76	7.53	11.29	12.69	----	----	----	----	----	----	----
1.75	Load (kPa) or (kN/m)	1	1.5	1.9	2.1	----	----	----	----	----	----	----
	U	6.47	9.71	12.32	----	----	----	----	----	----	----	----
	C	5.98	8.96	11.26	12.45	----	----	----	----	----	----	----
2	Load (kPa) or (kN/m)	0.5	1	1.4	----	----	----	----	----	----	----	----
	U	5.53	11.06	----	----	----	----	----	----	----	----	----
	C	4.42	8.85	12.39	----	----	----	----	----	----	----	----
LOAD kPa for Uniform Load or kN/m for Concentrated Line Load												
U mm. Deflection for Uniform Load												
C mm. Deflection for Concentrated Line Load												



Columns

Columns

Full section column testing was conducted on Treadwell Group's Equal Leg Angles, I Section, WF Section, and Square Hollow Section. Ultimate stress vs. slenderness ratio curves were developed from the testing. The curves developed are based on the Euler Buckling Stress Equation and a straight line transition from Euler Buckling to ultimate stress

$$\left[\pi^2 E / \left(\frac{Kl}{r} \right)^2 \right]$$

The allowable concentric axial load tables were generated from these curves. The tables are based on a safety factor of three.

Notation	
A	area (mm. ²)
b	width of flange/leg/wall (mm.)
t	thickness of flange (mm.)
r	minimum radius gyration (mm.)
l	length (m.)
K	effective column length factor
F _a	allowable column concentric axial stress (MPa)
P _a	allowable column centric axial load (N.)

Angle	Maximum allowable stress (F.O.S. = 3)	
	b/t ≤ 6	41.3MPa
	b/t = 8	33.5MPa
	b/t = 10.7	24.1MPa
	b/t = 12	19.5MPa
	b/t = 16	12.6MPa

WF & I Section	Maximum allowable stress (F.O.S. = 3)	
	b/t ≤ 12	68.9MPa
	b/t = 13.3	60.3 MPa
	b/t = 16	50.5MPa
	b/t = 20	32.3MPa
	b/t = 21.3	28.4MPa
	b/t = 24	22.4MPa
	b/t = 26.7	18.1MPa

Square Hollow Section (6.35mm wall)	Maximum allowable stress (F.O.S. = 3)	
	b/t ≤ 16	68.9MPa

Columns-Allowable Concentric Axial Stresses and Loads





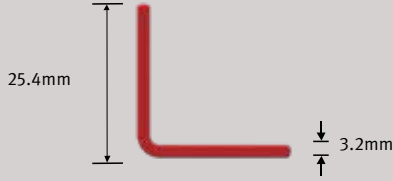

Angle

Columns – Allowable Concentric Axial Stresses and Loads

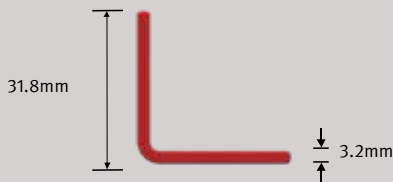
Part: 25.4 x 3.2mm		
Part Number: ARX-EL02503		
	A	151.2mm ²
	r	4.7mm
Effective Length (m)	F _a (kPa)	P _a (N)
0.3	13876	2098
0.5	4995	755
0.7	2549	385
0.9	1542	233
1.1	1032	156

Part: 31.8 x 3.2mm		
Part Number: ARX-EL03203		
	A	191.5mm ²
	r	6.0mm
Effective Length (m)	F _a (kPa)	P _a (N)
0.3	22631	4334
0.5	8147	1560
0.7	4157	796
0.9	2515	482
1.1	1683	322
1.3	1205	231

Columns – Allowable Concentric Axial Stresses and Loads

Part: 38.1 x 4.8mm		
Part Number: ARX-EL03805		
	A	339.3mm ²
	r	7.2mm
Effective Length (m)	F _a (kPa)	P _a (N)
0.3	33141	11245
0.5	11931	4048
0.7	6087	2065
0.9	3682	1249
1.1	2465	836
1.3	1765	599
1.5	1326	450
1.7	1032	350

Part: 38.1 x 6.4mm		
Part Number: ARX-EL03806		
	A	443.4mm ²
	r	7.2mm
Effective Length (m)	F _a (kPa)	P _a (N)
0.3	32837	14560
0.5	11821	5242
0.7	6031	2674
0.9	3649	1618
1.1	2442	1083
1.3	1749	775
1.5	1314	582
1.7	1023	453

Columns – Allowable Concentric Axial Stresses and Loads

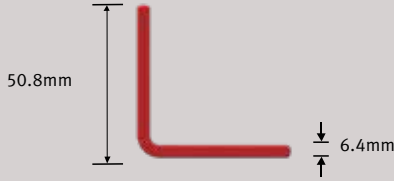
Part: 50.8 x 6.4mm		
Part Number: ARX-EL05106		
	A	604.7mm ²
	r	9.5mm
Effective Length (m)	F _a (kPa)	P _a (N)
0.3	35744	21615
0.5	20530	12415
0.7	10475	6334
0.9	6336	3831
1.1	4242	2565
1.3	3037	1837
1.5	2281	1379
1.7	1776	1074
1.9	1422	860
2.1	1164	704
2.3	970	587

Part: 76.2 x 6.4mm		
Part Number: ARX-EL07606		
	A	927.2mm ²
	r	14.6mm
Effective Length (m)	F _a (kPa)	P _a (N)
0.3	24354	22581
0.5	24354	22581
0.7	24354	22581
0.9	15128	14027
1.1	10127	9390
1.3	7251	6723
1.5	5446	5050
1.7	4240	3931
1.9	3394	3147
2.1	2779	2576
2.3	2316	2148
2.5	1961	1818
2.7	1681	1559
2.9	1457	1351
3.1	1275	1182
3.3	1125	1043
3.5	1000	928
3.7	895	830

Columns – Allowable Concentric Axial Stresses and Loads

Part: 76.2 x 9.5mm		
Part Number: ARX-EL07610		
	A	1360.5mm ²
	r	14.2mm
Effective Length (m)	F _a (kPa)	P _a (N)
0.3	35505	48304
0.5	35505	48304
0.7	23558	32051
0.9	14251	19389
1.1	9540	12979
1.3	6830	9293
1.5	5130	6980
1.7	3994	5434
1.9	3198	4350
2.1	2618	3561
2.3	2182	2969
2.5	1847	2513
2.7	1584	2154
2.9	1373	1867
3.1	1201	1634
3.3	1060	1442
3.5	942	1282
3.7	843	1147

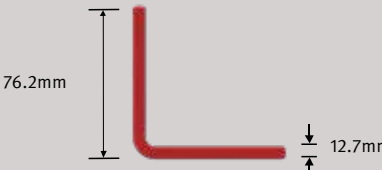
Part: 76.2 x 12.7mm		
Part Number: ARX-EL07613		
	A	1773.8mm ²
	r	13.8mm
Effective Length (m)	F _a (kPa)	P _a (N)
0.3	41305	73267
0.5	41305	73267
0.7	22284	39527
0.9	13480	23911
1.1	9024	16007
1.3	6461	11460
1.5	4853	8608
1.7	3778	6702
1.9	3025	5365
2.1	2476	4392
2.3	2064	3661
2.5	1747	3099
2.7	1498	2657
2.9	1298	2303
3.1	1136	2015
3.3	1003	1779
3.5	891	1581
3.7	798	1415

Columns – Allowable Concentric Axial Stresses and Loads

Part: 101.6 x 6.4mm		
Part Number: ARX-EL10206		
	A	1249.7mm ²
	r	19.8mm
Effective Length (m)	F _a (kPa)	P _a (N)
0.3	12964	16201
0.5	12964	16201
0.7	12964	16201
0.9	12964	16201
1.1	12964	16201
1.3	12964	16201
1.5	9973	12463
1.7	7764	9703
1.9	6216	7768
2.1	5088	6359
2.3	4242	5301
2.5	3590	4487
2.7	3078	3847
2.9	2668	3334
3.1	2335	2918
3.3	2061	2575
3.5	1832	2289
3.7	1639	2048
3.9	1475	1844

Columns – Allowable Concentric Axial Stresses and Loads

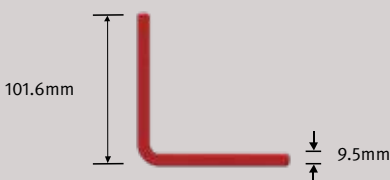
Part: 101.6 x 9.5mm		
Part Number: ARX-EL10210		
	A	1844.3mm ²
	r	19.4mm
Effective Length (m)	F _a (kPa)	P _a (N)
0.3	27831	51329
0.5	27831	51329
0.7	27831	51329
0.9	26480	48838
1.1	17726	32693
1.3	12692	23407
1.5	9533	17582
1.7	7422	13688
1.9	5942	10958
2.1	4864	8970
2.3	4055	7478
2.5	3432	6329
2.7	2942	5426
2.9	4237	7814
3.1	2550	4704
3.3	1970	3633
3.5	1751	3229
3.7	1567	2890
3.9	1410	2601
4.1	1276	2353
4.3	1160	2139
4.5	1059	1954
4.7	971	1791
4.9	893	1648

Columns – Allowable Concentric Axial Stresses and Loads

Part: 101.6 x 12.7mm		
Part Number: ARX-EL10213		
	A	2418.8mm ²
	r	18.9mm
Effective Length (m)	F _a (kPa)	P _a (N)
0.3	35565	86025
0.5	35565	86025
0.7	35565	86025
0.9	25336	61283
1.1	16961	41024
1.3	12143	29373
1.5	9121	22062
1.7	7101	17176
1.9	5685	13751
2.1	4654	11256
2.3	3880	9384
2.5	3284	7942
2.7	2815	6809
2.9	2440	5902
3.1	2136	5165
3.3	1885	4558
3.5	1675	4052
3.7	1499	3626
3.9	1349	3264
4.1	1221	2953
4.3	1110	2685
4.5	1014	2451
4.7	929	2247

Columns – Allowable Concentric Axial Stresses and Loads

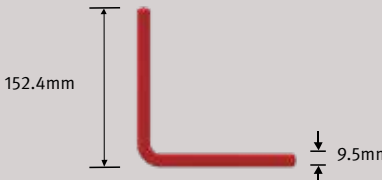
Part: 152.4 x 9.5mm		
Part Number: ARX-EL15210		
	A	2811.8mm ²
	r	29.7mm
Effective Length (m)	F _a (kPa)	P _a (N)
0.3	12484	35103
0.5	12484	35103
0.7	12484	35103
0.9	12484	35103
1.1	12484	35103
1.3	12484	35103
1.5	12484	35103
1.7	12484	35103
1.9	12484	35103
2.1	11445	32182
2.3	9541	26829
2.5	8076	22708
2.7	6924	19468
2.9	6002	16875
3.1	5252	14768
3.3	4635	13032
3.5	4120	11586
3.7	3687	10367
3.9	3319	9331
4.1	3003	8443
4.3	2730	7676
4.5	2493	7009
4.7	2285	6425
4.9	2102	5911
5.1	1941	5457
5.3	1797	5052
5.5	1669	4692
5.7	1554	4368
5.9	1450	4077
6.1	1357	3814
6.3	1272	3576
6.5	1195	3359
6.7	1124	3162
6.9	1060	2981
7.1	1001	2815
7.3	947	2663
7.5	897	2523

Columns – Allowable Concentric Axial Stresses and Loads

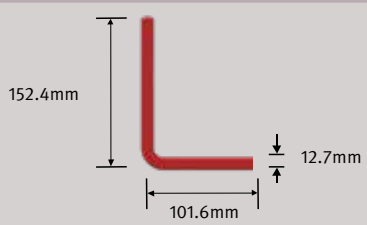
Part: 152.4 x 101.6 x 12.7mm		
Part Number: ARX-UL15210213		
	A	3707.8mm ²
	r	21.4mm
Effective Length (m)	F _a (kPa)	P _a (N)
0.3	24085	89302
0.5	24085	89302
0.7	24085	89302
0.9	24085	89302
1.1	21638	80230
1.3	15493	57443
1.5	11637	43146
1.7	9060	33591
1.9	7253	26892
2.1	5937	22013
2.3	4949	18351
2.5	4189	15533
2.7	3592	13317
2.9	3113	11543
3.1	2725	10102
3.3	2404	8915
3.5	2137	7925
3.7	1913	7091
3.9	1721	6383
4.1	1558	5775
4.3	1416	5250
4.5	1293	4794
4.7	1185	4395
4.9	1091	4043
5.1	1007	3732
5.3	932	3456
5.5	866	3209
5.7	806	2988
5.9	752	2789
6.1	704	2609
6.3	660	2446
6.5	620	2298
6.7	583	2163
6.9	550	2039
7.1	519	1926
7.3	491	1822
7.5	466	1726

Columns – Allowable Concentric Axial Stresses and Loads

152.4 X 152.4 X 12.7mm Angle		
	A	3677.4mm ²
	r	30.2mm
Effective Length (m)	F _a (kPa)	P _a (N)
0.30	18204	66942
0.46	17539	64498
0.61	16874	62054
0.76	16210	59610
0.91	15545	57166
1.07	14881	54722
1.22	14216	52278
1.37	13551	49834
1.52	12887	47390
1.68	12222	44945
1.83	11557	42501
1.98	10893	40057
2.13	10228	37613
2.29	9564	35169
2.44	8899	32725
2.59	8234	30281
2.74	7570	27837
2.90	6905	25393
3.05	6246	22968
3.20	5665	20833
3.35	5162	18982
3.51	4723	17367
3.66	4337	15950
3.81	3997	14700
3.96	3696	13591
4.12	3427	12603
4.27	3187	11719
4.42	2971	10924
4.57	2776	10208
4.72	2600	9560
4.88	2440	8972
5.03	2294	8437
5.18	2161	7948
5.33	2039	7500
5.49	1928	7089
5.64	1825	6711
5.79	1730	6362

I Section



Columns – Allowable Concentric Axial Stresses and Loads

Part: 76.2 x 38.1 x 6.4mm		
Part Number: ARX-IS07603806		
	A	886.9mm ²
	r	8.2mm
Effective Length (m)	F _a (kPa)	P _a (N)
0.3	42947	38089
0.5	15461	13712
0.7	7888	6996
0.9	4772	4232
1.1	3194	2833
1.3	2287	2028
1.5	1718	1524
1.7	1337	1186
1.9	1071	950
2.1	877	777
2.3	731	648
2.5	618	549
2.7	530	470
2.9	460	408
3.1	402	357
3.3	355	315
3.5	316	280
3.7	282	250
3.9	254	225
4.1	230	204
4.3	209	185
4.5	191	169
4.7	175	155
4.9	161	143
5.1	149	132
5.3	138	122
5.5	128	113
5.7	119	106
5.9	111	99
6.1	104	92
6.3	97	86
6.5	92	81
6.7	86	76
6.9	81	72
7.1	77	68
7.3	73	64
7.5	69	61
7.7	65	58
7.9	62	55

Columns – Allowable Concentric Axial Stresses and Loads

Part: 88.9 x 38.1 x 4.8mm		
Part Number: ARX-IS08903805		
	A	740.7mm ²
	r	7.8mm
Effective Length (m)	F _a (kPa)	P _a (N)
0.3	38306	28373
0.5	13790	10214
0.7	7036	5211
0.9	4256	3153
1.1	2849	2110
1.3	2040	1511
1.5	1532	1135
1.7	1193	884
1.9	955	707
2.1	782	579
2.3	652	483
2.5	552	409
2.7	473	350
2.9	410	304
3.1	359	266
3.3	317	235
3.5	281	209
3.7	252	187
3.9	227	168
4.1	205	152
4.3	187	138
4.5	170	126
4.7	156	116
4.9	144	106
5.1	133	98
5.3	123	91
5.5	114	84
5.7	106	79
5.9	99	73
6.1	93	69
6.3	87	64
6.5	82	60
6.7	77	57
6.9	72	54
7.1	68	51
7.3	65	48
7.5	61	45
7.7	58	43
7.9	55	41

Columns – Allowable Concentric Axial Stresses and Loads

Part: 101.6 x 50.8 x 6.4mm		
Part Number: ARX-IS10205106		
	A	1209.4mm ²
	r	10.8mm
Effective Length (m)	F _a (kPa)	P _a (N)
0.3	68900	83328
0.5	26626	32202
0.7	13585	16430
0.9	8218	9939
1.1	5501	6653
1.3	3939	4764
1.5	2959	3578
1.7	2303	2786
1.9	1844	2230
2.1	1509	1826
2.3	1258	1522
2.5	1065	1288
2.7	913	1104
2.9	792	957
3.1	693	838
3.3	611	739
3.5	543	657
3.7	486	588
3.9	438	529
4.1	396	479
4.3	360	435
4.5	329	398
4.7	301	364
4.9	277	335
5.1	256	310
5.3	237	287
5.5	220	266
5.7	205	248
5.9	191	231
6.1	179	216
6.3	168	203
6.5	158	191
6.7	148	179
6.9	140	169
7.1	132	160
7.3	125	151
7.5	118	143
7.7	112	136
7.9	107	129

Columns – Allowable Concentric Axial Stresses and Loads

Part: 139.7 x 63.5 x 6.4mm		
Part Number: ARX-IS14006406		
	A	1612.5mm ²
	r	13.0mm
Effective Length (m)	F _a (kPa)	P _a (N)
0.3	68900	111101
0.5	38862	62666
0.7	19828	31972
0.9	11995	19341
1.1	8029	12947
1.3	5749	9270
1.5	4318	6963
1.7	3362	5421
1.9	2691	4340
2.1	2203	3553
2.3	1837	2962
2.5	1555	2507
2.7	1333	2149
2.9	1155	1863
3.1	1011	1630
3.3	892	1439
3.5	793	1279
3.7	710	1144
3.9	639	1030
4.1	578	932
4.3	526	847
4.5	480	774
4.7	440	709
4.9	405	653
5.1	374	602
5.3	346	558
5.5	321	518
5.7	299	482
5.9	279	450
6.1	261	421
6.3	245	395
6.5	230	371
6.7	216	349
6.9	204	329
7.1	193	311
7.3	182	294
7.5	173	279
7.7	164	264
7.9	156	251

Columns – Allowable Concentric Axial Stresses and Loads

Part: 152.4 X 76.2 X 6.4mm		
Part Number: ARX-IS15207606		
	A	1854.4mm ²
	r	15.9mm
Effective Length (m)	F _a (kPa)	P _a (N)
0.3	68900	127768
0.5	58184	107897
0.7	29686	55050
0.9	17958	33302
1.1	12022	22293
1.3	8607	15961
1.5	6465	11989
1.7	5033	9334
1.9	4029	7472
2.1	3298	6117
2.3	2750	5099
2.5	2327	4316
2.7	1995	3700
2.9	1730	3207
3.1	1514	2807
3.3	1336	2477
3.5	1187	2202
3.7	1063	1970
3.9	956	1774
4.1	865	1605
4.3	787	1459
4.5	718	1332
4.7	659	1221
4.9	606	1124
5.1	559	1037
5.3	518	960
5.5	481	892
5.7	448	830
5.9	418	775
6.1	391	725
6.3	367	680
6.5	344	638
6.7	324	601
6.9	306	567
7.1	289	535
7.3	273	506
7.5	259	480
7.7	245	455
7.9	233	432

Columns – Allowable Concentric Axial Stresses and Loads

Part: 152.4 x 76.2 x 9.5mm		
Part Number: ARX-IS15207610		
	A	2721.1mm ²
	r	16.2mm
Effective Length (m)	F _a (kPa)	P _a (N)
0.3	68900	187484
0.5	59910	163020
0.7	30566	83174
0.9	18491	50315
1.1	12378	33682
1.3	8862	24115
1.5	6657	18113
1.7	5183	14102
1.9	4149	11290
2.1	3396	9242
2.3	2831	7704
2.5	2396	6521
2.7	2055	5591
2.9	1781	4846
3.1	1559	4241
3.3	1375	3742
3.5	1223	3327
3.7	1094	2977
3.9	985	2680
4.1	891	2424
4.3	810	2204
4.5	740	2013
4.7	678	1845
4.9	624	1697
5.1	576	1567
5.3	533	1451
5.5	495	1347
5.7	461	1254
5.9	430	1171
6.1	403	1095
6.3	377	1027
6.5	355	965
6.7	334	908
6.9	315	856
7.1	297	809
7.3	281	765
7.5	266	725
7.7	253	687
7.9	240	653

Columns – Allowable Concentric Axial Stresses and Loads

Part: 203.2 x 101.6 x 9.5mm		
Part Number: ARX-IS20310210		
	A	3688.6mm ²
	r	21.3mm
Effective Length (m)	F _a (kPa)	P _a (N)
0.3	68900	254145
0.5	68900	254145
0.7	53148	196042
0.9	32151	118593
1.1	21523	79389
1.3	15410	56841
1.5	11574	42694
1.7	9011	33239
1.9	7214	26610
2.1	5905	21782
2.3	4923	18159
2.5	4167	15370
2.7	3572	13177
2.9	3097	11422
3.1	2710	9996
3.3	2391	8821
3.5	2126	7842
3.7	1902	7017
3.9	1712	6316
4.1	1549	5715
4.3	1409	5195
4.5	1286	4744
4.7	1179	4349
4.9	1085	4001
5.1	1001	3693
5.3	927	3420
5.5	861	3176
5.7	802	2957
5.9	748	2760
6.1	700	2582
6.3	656	2420
6.5	616	2274
6.7	580	2140
6.9	547	2018
7.1	517	1906
7.3	489	1803
7.5	463	1708
7.7	439	1620
7.9	417	1539

Columns – Allowable Concentric Axial Stresses and Loads

Part: 203.2 x 101.6 x 12.7mm		
Part Number: ARX-IS20310213		
	A	4837.5mm ²
	r	21.6mm
Effective Length (m)	F _a (kPa)	P _a (N)
0.3	68900	333304
0.5	68900	333304
0.7	54340	262868
0.9	32872	159019
1.1	22005	106451
1.3	15755	76216
1.5	11834	57247
1.7	9213	44569
1.9	7376	35680
2.1	6038	29208
2.3	5033	24349
2.5	4260	20609
2.7	3653	17669
2.9	3166	15316
3.1	2771	13403
3.3	2445	11828
3.5	2174	10515
3.7	1945	9409
3.9	1751	8469
4.1	1584	7662
4.3	1440	6966
4.5	1315	6361
4.7	1205	5831
4.9	1109	5365
5.1	1024	4952
5.3	948	4585
5.5	880	4258
5.7	820	3965
5.9	765	3700
6.1	716	3462
6.3	671	3245
6.5	630	3049
6.7	593	2869
6.9	559	2705
7.1	528	2555
7.3	500	2417
7.5	473	2290
7.7	449	2173
7.9	427	2064

Columns – Allowable Concentric Axial Stresses and Loads

Part: 254 x 127 x 9.5mm		
Part Number: ARX-IS25412710		
	A	4656.1mm ²
	r	26.5mm
Effective Length (m)	F _a (kPa)	P _a (N)
0.3	64165	298760
0.5	64165	298760
0.7	64165	298760
0.9	49611	230992
1.1	33210	154631
1.3	23778	110712
1.5	17860	83157
1.7	13905	64742
1.9	11132	51829
2.1	9112	42427
2.3	7596	35369
2.5	6430	29937
2.7	5512	25666
2.9	4778	22248
3.1	4182	19470
3.3	3690	17181
3.5	3280	15274
3.7	2935	13667
3.9	2642	12301
4.1	2391	11131
4.3	2173	10119
4.5	1984	9240
4.7	1819	8470
4.9	1674	7793
5.1	1545	7194
5.3	1431	6661
5.5	1328	6185
5.7	1237	5759
5.9	1154	5375
6.1	1080	5028
6.3	1013	4714
6.5	951	4429
6.7	895	4168
6.9	844	3930
7.1	797	3712
7.3	754	3511
7.5	714	3326
7.7	678	3156
7.9	644	2998

Columns – Allowable Concentric Axial Stresses and Loads

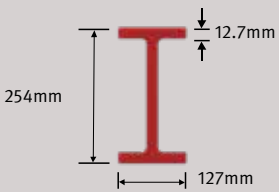
Part: 254 x 127 x 12.7mm		
Part Number: ARX-IS25412713		
	A	6127.5mm ²
	r	26.7mm
Effective Length (m)	F _a (kPa)	P _a (N)
0.3	68900	422185
0.5	68900	422185
0.7	68900	422185
0.9	50453	309152
1.1	33775	206953
1.3	24182	148174
1.5	18163	111295
1.7	14141	86648
1.9	11321	69367
2.1	9267	56783
2.3	7725	47337
2.5	6539	40066
2.7	5606	34350
2.9	4859	29776
3.1	4253	26058
3.3	3753	22995
3.5	3336	20442
3.7	2985	18292
3.9	2687	16464
4.1	2431	14897
4.3	2210	13543
4.5	2018	12366
4.7	1850	11336
4.9	1702	10430
5.1	1571	9628
5.3	1455	8915
5.5	1351	8278
5.7	1258	7707
5.9	1174	7194
6.1	1098	6730
6.3	1030	6309
6.5	967	5927
6.7	910	5578
6.9	858	5260
7.1	811	4968
7.3	767	4699
7.5	727	4452
7.7	689	4224
7.9	655	4012

Columns – Allowable Concentric Axial Stresses and Loads

Part: 304.8 x 152.4 x 12.7mm		
Part Number: ARX-IS30515213		
	A	7417.5mm ²
	r	31.9mm
Effective Length (m)	F _a (kPa)	P _a (N)
0.3	68900	511066
0.5	68900	511066
0.7	68900	511066
0.9	68900	511066
1.1	48086	356680
1.3	34429	255374
1.5	25860	191815
1.7	20133	149337
1.9	16118	119552
2.1	13194	97865
2.3	10999	81585
2.5	9310	69053
2.7	7981	59202
2.9	6919	51318
3.1	6055	44910
3.3	5343	39631
3.5	4750	35231
3.7	4250	31525
3.9	3825	28375
4.1	3461	25674
4.3	3147	23341
4.5	2873	21313
4.7	2634	19538
4.9	2423	17975
5.1	2237	16593
5.3	2071	15364
5.5	1924	14267
5.7	1791	13284
5.9	1672	12398
6.1	1564	11599
6.3	1466	10874
6.5	1377	10215
6.7	1296	9614
6.9	1222	9065
7.1	1154	8562
7.3	1092	8099
7.5	1034	7673
7.7	981	7279
7.9	932	6915

Columns – Allowable Concentric Axial Stresses and Loads

Part: 457.2 X 9.5 X 114.3 X 12.7mm		
Part Number: ARX-IS45711413		
	A	7014.4mm ²
	r	21.3mm
Effective Length (m)	F _a (kPa)	P _a (N)
0.3	68900	483292
0.5	68900	483292
0.7	53157	372864
0.9	32157	225560
1.1	21526	150995
1.3	15412	108109
1.5	11576	81202
1.7	9013	63219
1.9	7215	50610
2.1	5906	41429
2.3	4924	34538
2.5	4168	29233
2.7	3573	25062
2.9	3097	21725
3.1	2710	19012
3.3	2392	16777
3.5	2126	14915
3.7	1903	13346
3.9	1713	12012
4.1	1550	10869
4.3	1409	9881
4.5	1286	9022
4.7	1179	8271
4.9	1085	7610
5.1	1001	7024
5.3	927	6504
5.5	861	6040
5.7	802	5623
5.9	748	5249
6.1	700	4910
6.3	656	4603
6.5	617	4324
6.7	580	4070
6.9	204	329
7.1	547	3838
7.3	489	3429
7.5	463	3248
7.7	439	3082
7.9	417	2928

Columns – Allowable Concentric Axial Stresses and Loads

Part: 609.6 X 9.5 X 190.5 X 19.1mm		
Part Number: ARX-IS61019119		
	A	12698.4mm ²
	r	41.6mm
Effective Length (m)	F _a (kPa)	P _a (N)
0.3	68900	874920
0.5	68900	874920
0.7	68900	874920
0.9	68900	874920
1.1	68900	874920
1.3	58655	744829
1.5	44057	559449
1.7	34300	435557
1.9	27459	348687
2.1	22478	285433
2.3	18739	237951
2.5	15860	201402
2.7	13598	172670
2.9	11787	149674
3.1	10315	130985
3.3	9103	115589
3.5	8092	102756
3.7	7241	91948
3.9	6517	82759
4.1	5897	74882
4.3	5361	68078
4.5	4895	62161
4.7	4487	56983
4.9	4129	52427
5.1	3811	48395
5.3	3529	44812
5.5	3277	41612
5.7	3051	38743
5.9	2848	36161
6.1	2664	33829
6.3	2498	31715
6.5	2346	29793
6.7	2208	28041
6.9	2082	26439
7.1	1966	24971
7.3	1860	23621
7.5	1762	22378
7.7	1672	21231
7.9	1588	20169

WF Section

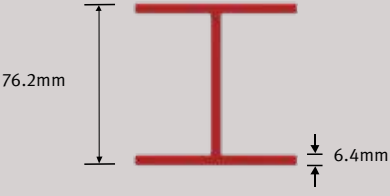

Columns – Allowable Concentric Axial Stresses and Loads

Part: 76.2 x 6.4mm		
Part Number: ARX-WF07606		
	A	1374.2mm ²
	r	18.5mm
Effective Length (m)	F _a (kPa)	P _a (N)
0.3	68900	94682
0.5	68900	94682
0.7	39982	54944
0.9	24187	33238
1.1	16191	22250
1.3	11593	15931
1.5	8707	11966
1.7	6779	9316
1.9	5427	7458
2.1	4443	6105
2.3	3704	5089
2.5	3135	4308
2.7	2687	3693
2.9	2330	3201
3.1	2039	2802
3.3	1799	2472
3.5	1599	2198
3.7	1431	1967
3.9	1288	1770
4.1	1166	1602
4.3	1060	1456
4.5	968	1330
4.7	887	1219

Columns – Allowable Concentric Axial Stresses and Loads

Part: 101.6 x 6.4mm		
Part Number: ARX-WF10206		
	A	1864.5mm ²
	r	24.4mm
Effective Length (m)	F _a (kPa)	P _a (N)
0.3	55493	103466
0.5	55493	103466
0.7	55493	103466
0.9	42121	78535
1.1	28197	52573
1.3	20188	37641
1.5	15164	28273
1.7	11806	22012
1.9	9451	17621
2.1	7737	14425
2.3	6450	12025
2.5	5459	10178
2.7	4680	8726
2.9	4057	7564
3.1	3550	6620
3.3	3133	5841
3.5	2785	5193
3.7	2492	4647
3.9	2243	4182
4.1	2030	3784
4.3	1845	3440
4.5	1685	3141
4.7	1545	2880
4.9	1421	2650
5.1	1312	2446
5.3	1215	2265
5.5	1128	2103
5.7	1050	1958
5.9	980	1827
6.1	917	1710
6.3	860	1603

Columns – Allowable Concentric Axial Stresses and Loads

Part: 152.4 x 6.4mm		
Part Number: ARX-WF15206		
	A	2832.3mm ²
	r	36.4mm
Effective Length (m)	F _a (kPa)	P _a (N)
0.3	28029	79386
0.5	28029	79386
0.7	28029	79386
0.9	28029	79386
1.1	28029	79386
1.3	28029	79386
1.5	28029	79386
1.7	26226	74279
1.9	20995	59464
2.1	17186	48677
2.3	14327	40580
2.5	12127	34347
2.7	10397	29447
2.9	9012	25525
3.1	7887	22338
3.3	6960	19712
3.5	6187	17524
3.7	5536	15681
3.9	4983	14113
4.1	4509	12770
4.3	4099	11610
4.5	3743	10601
4.7	3431	9718
4.9	3157	8941
5.1	2914	8253
5.3	2698	7642
5.5	2506	7096
5.7	2333	6607
5.9	2177	6167
6.1	2037	5769
6.3	1910	5409
6.5	1794	5081
6.7	1688	4782
6.9	1592	4509
7.1	1504	4258
7.3	1422	4028
7.5	1347	3816
7.7	1278	3621
7.9	1214	3440

Columns – Allowable Concentric Axial Stresses and Loads

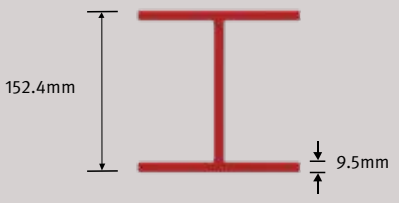
Part: 152.4 x 9.5mm		
Part Number: ARX-WF15210		
	A	4180.6mm ²
	r	36.7mm
Effective Length (m)	F _a (kPa)	P _a (N)
0.3	54914	229575
0.5	54914	229575
0.7	54914	229575
0.9	54914	229575
1.1	54914	229575
1.3	45592	190602
1.5	34245	143163
1.7	26661	111459
1.9	21344	89229
2.1	17472	73042
2.3	14565	60892
2.5	12328	51539
2.7	10569	44186
2.9	9162	38302
3.1	8018	33519
3.3	7075	29579
3.5	6290	26295
3.7	5628	23529
3.9	5066	21178
4.1	4584	19162
4.3	4167	17421
4.5	3805	15907
4.7	3488	14582
4.9	3209	13416
5.1	2962	12384
5.3	2743	11467
5.5	2547	10649
5.7	2372	9914
5.9	2214	9254
6.1	2071	8657
6.3	1941	8116
6.5	1824	7624
6.7	1716	7176
6.9	1618	6766
7.1	1529	6390
7.3	1446	6045
7.5	1370	5727
7.7	1300	5433
7.9	1235	5161

Columns – Allowable Concentric Axial Stresses and Loads

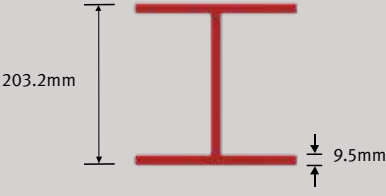
Part: 203.2 x 9.5mm		
Part Number: ARX-WF20310		
	A	5632.2mm ²
	r	48.7mm
Effective Length (m)	F _a (kPa)	P _a (N)
0.3	36412	205082
0.5	36412	205082
0.7	36412	205082
0.9	36412	205082
1.1	36412	205082
1.3	36412	205082
1.5	36412	205082
1.7	36412	205082
1.9	36412	205082
2.1	30724	173044
2.3	25613	144258
2.5	21679	122100
2.7	18586	104681
2.9	16111	90740
3.1	14099	79409
3.3	12442	70076
3.5	11061	62296
3.7	9897	55743
3.9	8908	50172
4.1	8060	45397
4.3	7328	41272
4.5	6691	37685
4.7	6134	34546
4.9	5643	31784
5.1	5209	29340
5.3	4824	27167
5.5	4479	25227
5.7	4170	23488
5.9	3892	21923
6.1	3641	20509
6.3	3414	19227
6.5	3207	18062
6.7	3018	17000
6.9	2846	16029
7.1	2688	15138
7.3	2543	14320
7.5	2409	13567
7.7	2285	12871
7.9	2171	12228

Columns – Allowable Concentric Axial Stresses and Loads

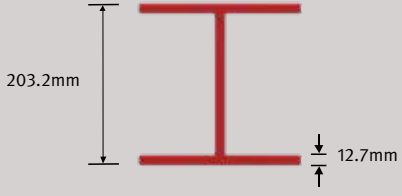
Part: 203.2 x 12.7mm		
Part Number: ARX-WF20313		
	A	7425.8mm ²
	r	48.9mm
Effective Length (m)	F _a (kPa)	P _a (N)
0.3	55060	408865
0.5	55060	408865
0.7	55060	408865
0.9	55060	408865
1.1	55060	408865
1.3	55060	408865
1.5	55060	408865
1.7	47449	352350
1.9	37986	282075
2.1	31095	230905
2.3	25922	192493
2.5	21941	162926
2.7	18811	139683
2.9	16305	121081
3.1	14269	105962
3.3	12592	93507
3.5	11194	83126
3.7	10017	74382
3.9	9016	66949
4.1	8158	60577
4.3	7416	55073
4.5	6772	50286
4.7	6208	46097
4.9	5711	42411
5.1	5272	39150
5.3	4882	36251
5.5	4533	33663
5.7	4221	31342
5.9	3939	29253
6.1	3685	27366
6.3	3455	25656
6.5	3246	24102
6.7	3055	22684
6.9	2880	21388
7.1	2720	20200
7.3	2573	19109
7.5	2438	18103
7.7	2313	17175
7.9	2197	16316

Columns – Allowable Concentric Axial Stresses and Loads

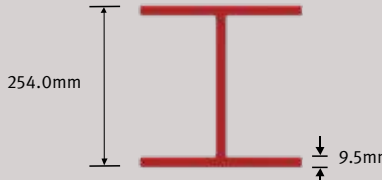
Part: 254.0 x 9.5mm		
Part Number: ARX-WF25410		
	A	7135.5mm ²
	r	60.4mm
Effective Length (m)	F _a (kPa)	P _a (N)
0.3	17911	127800
0.5	17911	127800
0.7	17911	127800
0.9	17911	127800
1.1	17911	127800
1.3	17911	127800
1.5	17911	127800
1.7	17911	127800
1.9	17911	127800
2.1	17911	127800
2.3	17911	127800
2.5	17911	127800
2.7	17911	127800
2.9	17911	127800
3.1	17911	127800
3.3	17911	127800
3.5	17047	121635
3.7	15253	108841
3.9	13729	97964
4.1	12422	88640
4.3	11294	80586
4.5	10312	73582
4.7	9453	67453
4.9	8697	62059
5.1	8028	57287
5.3	7434	53045
5.5	6903	49257
5.7	6427	45861
5.9	5999	42805
6.1	5612	40044
6.3	5261	37542
6.5	4943	35267
6.7	4652	33193
6.9	4386	31297
7.1	4142	29558
7.3	3919	27961
7.5	3712	26489
7.7	3522	25131
7.9	3346	23875

Columns – Allowable Concentric Axial Stresses and Loads

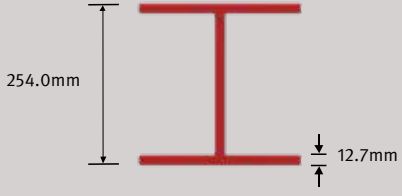
Part: 254.0 x 12.7mm		
Part Number: ARX-WF25413		
	A	9361.3mm ²
	r	60.9mm
Effective Length (m)	F _a (kPa)	P _a (N)
0.3	41220	385873
0.5	41220	385873
0.7	41220	385873
0.9	41220	385873
1.1	41220	385873
1.3	41220	385873
1.5	41220	385873
1.7	41220	385873
1.9	41220	385873
2.1	41220	385873
2.3	40134	375709
2.5	33970	318000
2.7	29124	272634
2.9	25245	236326
3.1	22093	206816
3.3	19496	182507
3.5	17332	162245
3.7	15508	145179
3.9	13959	130671
4.1	12630	118233
4.3	11482	107491
4.5	10485	98148
4.7	9611	89973
4.9	8843	82778
5.1	8163	76413
5.3	7558	70755
5.5	7019	65703
5.7	6535	61173
5.9	6099	57096
6.1	5706	53413
6.3	5349	50076
6.5	5025	47041
6.7	4730	44275
6.9	4459	41745
7.1	4212	39427
7.3	3984	37296
7.5	3774	35333
7.7	3581	33522
7.9	3402	31846

Columns – Allowable Concentric Axial Stresses and Loads

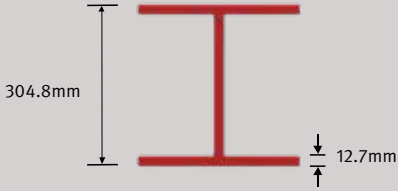
Part: 304.8 x 12.7mm		
Part Number: ARX-WF30513		
	A	11296.8mm ²
	r	72.9mm
Effective Length (m)	F _a (kPa)	P _a (N)
0.3	27380	309306
0.5	27380	309306
0.7	27380	309306
0.9	27380	309306
1.1	27380	309306
1.3	27380	309306
1.5	27380	309306
1.7	27380	309306
1.9	27380	309306
2.1	27380	309306
2.3	27380	309306
2.5	27380	309306
2.7	27380	309306
2.9	27380	309306
3.1	27380	309306
3.3	27380	309306
3.5	24811	280282
3.7	22201	250800
3.9	19982	225737
4.1	18080	204251
4.3	16438	185692
4.5	15009	169553
4.7	13759	155430
4.9	12659	143001
5.1	11685	132005
5.3	10820	122231
5.5	10047	113503
5.7	9355	105677
5.9	8731	98634
6.1	8168	92272
6.3	7658	86507
6.5	7194	81265
6.7	6771	76486
6.9	6384	72116
7.1	6029	68111
7.3	5703	64430
7.5	5403	61039
7.7	5126	57910
7.9	4870	55015



Double Web Section

Columns – Allowable Concentric Axial Stresses and Loads

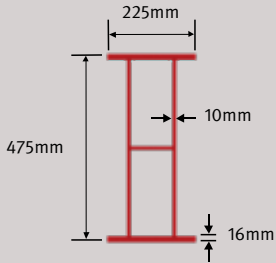
Part: 475 X 225 x 10 x 16mm		
Part Number: ARX-DW4752251016		
	A	16060mm ²
	r	54.9mm
Effective Length (m)	F _a (kPa)	P _a (N)
3.05	20889	335477
3.20	18976	304755
3.35	17315	278079
3.51	15772	253298
3.66	14566	233930
3.81	13386	214979
3.96	12391	198999
4.12	11448	183855
4.27	10656	171135
4.42	9946	159733
4.57	9304	149422
4.72	8722	140075
4.88	8160	131050
5.03	7680	123341
5.18	7242	116307
5.33	6840	109850
5.49	6447	103539
5.64	6109	98111
5.79	5796	93084
5.94	5507	88442
6.10	5222	83865

A stack of square hollow sections (SHS) is shown in a dark, dimly lit environment. The sections are stacked in a way that shows their hollow, square cross-sections. The lighting is dramatic, highlighting the edges and the interior of the sections. The background is a dark, textured surface.

Square Hollow Section

Columns – Allowable Concentric Axial Stresses and Loads

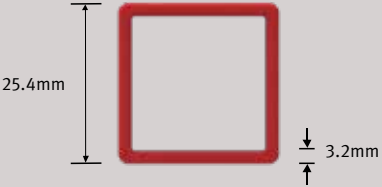
Part: 25.4 X 3.2mm		
Part Number: ARX-SH02503		
	A	282.2mm ²
	r	9.2mm
Effective Length (m)	F _a (kPa)	P _a (N)
0.3	53440	15081
0.5	19238	5429
0.7	9816	2770
0.9	5938	1676
1.1	3975	1122
1.3	2846	803
1.5	2138	603
1.7	1664	470
1.9	1332	376
2.1	1091	308

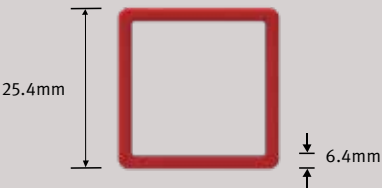
Part: 25.4 X 6.4mm		
Part Number: ARX-SH02506		
	A	483.8mm ²
	r	8.2mm
Effective Length (m)	F _a (kPa)	P _a (N)
0.3	42752	20684
0.5	15391	7446
0.7	7852	3799
0.9	4750	2298
1.1	3180	1538
1.3	2277	1102
1.5	1710	827
1.7	1331	644
1.9	1066	516
2.1	873	422

Columns – Allowable Concentric Axial Stresses and Loads

Part: 31.8 X 3.2mm		
Part Number: ARX-SH03203		
<p>31.8mm</p> <p>3.2mm</p>	A	362.8mm ²
	r	11.7mm
Effective Length (m)	F _a (kPa)	P _a (N)
0.3	68900	24997
0.5	31552	11447
0.7	16098	5840
0.9	9738	3533
1.1	6519	2365
1.3	4667	1693
1.5	3506	1272
1.7	2729	990
1.9	2185	793
2.1	1789	649
2.3	1491	541
2.5	1262	458

Part: 31.8 X 6.4mm		
Part Number: ARX-SH03206		
<p>31.8mm</p> <p>6.4mm</p>	A	645mm ²
	r	10.7mm
Effective Length (m)	F _a (kPa)	P _a (N)
0.3	68900	44441
0.5	26165	16876
0.7	13349	8610
0.9	8076	5209
1.1	5406	3487
1.3	3871	2497
1.5	2907	1875
1.7	2263	1460
1.9	1812	1169
2.1	1483	957
2.3	1237	798
2.5	1047	675

Columns – Allowable Concentric Axial Stresses and Loads

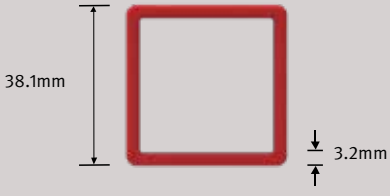
Part: 38.1 X 3.2mm		
Part Number: ARX-SH03803		
	A	443.4mm ²
	r	14.3mm
Effective Length (m)	F _a (kPa)	P _a (N)
0.3	68900	30550
0.5	46942	20814
0.7	23950	10619
0.9	14488	6424
1.1	9699	4300
1.3	6944	3079
1.5	5216	2313
1.7	4061	1801
1.9	3251	1441
2.1	2661	1180
2.3	2218	984
2.5	1878	833
2.7	1610	714
2.9	1395	619
3.1	1221	542
3.3	1078	478

Columns – Allowable Concentric Axial Stresses and Loads

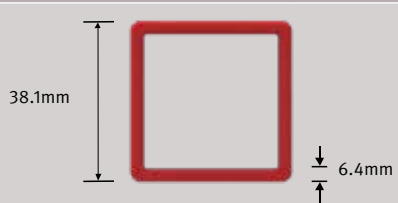
Part: 38.1 x 6.4mm		
Part Number: ARX-SH03806		
	A	806.2mm ²
	r	13.2mm
Effective Length (m)	F _a (kPa)	P _a (N)
0.3	68900	55547
0.5	40016	32261
0.7	20417	16460
0.9	12351	9957
1.1	8268	6666
1.3	5920	4772
1.5	4446	3585
1.7	3462	2791
1.9	2771	2234
2.1	2269	1829
2.3	1891	1525
2.5	1601	1290
2.7	1372	1106
2.9	1190	959
3.1	1041	839
3.3	919	741

Columns – Allowable Concentric Axial Stresses and Loads

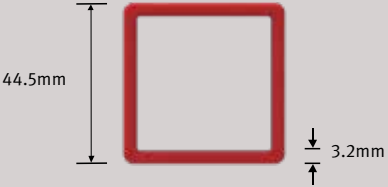
Part: 44.5 X 3.2mm		
Part Number: ARX-SH04503		
	A	524.1mm ²
	r	16.9mm
Effective Length (m)	F _a (kPa)	P _a (N)
0.3	62304	32654
0.5	62304	32654
0.7	33374	17491
0.9	20189	10581
1.1	13515	7083
1.3	9676	5071
1.5	7268	3809
1.7	5659	2966
1.9	4530	2374
2.1	3708	1943
2.3	3091	1620
2.5	2617	1371
2.7	2243	1176
2.9	1945	1019
3.1	1702	892
3.3	1502	787
3.5	1335	700
3.7	1195	626
3.9	1075	564

Columns – Allowable Concentric Axial Stresses and Loads

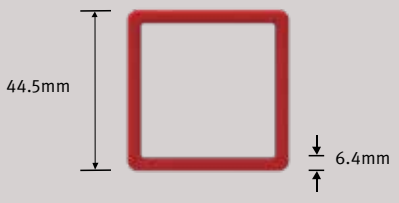
Part: 44.5 x 6.4mm		
Part Number: ARX-SH04506		
	A	967.5mm ²
	r	15.8mm
Effective Length (m)	F _a (kPa)	P _a (N)
0.3	68900	66661
0.5	56946	55096
0.7	29054	28110
0.9	17576	17005
1.1	11766	11383
1.3	8424	8150
1.5	6327	6122
1.7	4926	4766
1.9	3944	3816
2.1	3228	3123
2.3	2691	2604
2.5	2278	2204
2.7	1953	1889
2.9	1693	1638
3.1	1481	1433
3.3	1307	1265
3.5	1162	1124
3.7	1040	1006
3.9	936	906

Columns – Allowable Concentric Axial Stresses and Loads

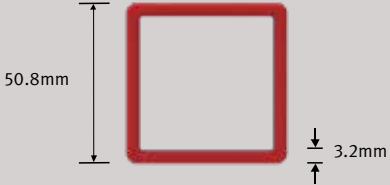
Part: 50.8 X 3.2mm		
Part Number: ARX-SH05103		
	A	604.7mm ²
	r	19.5mm
Effective Length (m)	F _a (kPa)	P _a (N)
0.3	55493	33556
0.5	55493	33556
0.7	44367	26828
0.9	26839	16230
1.1	17967	10864
1.3	12864	7779
1.5	9662	5843
1.7	7522	4549
1.9	6022	3642
2.1	4930	2981
2.3	4110	2485
2.5	3478	2103
2.7	2982	1803
2.9	2585	1563
3.1	2262	1368
3.3	1996	1207
3.5	1775	1073
3.7	1588	960
3.9	1429	864
4.1	1293	782
4.3	1176	711
4.5	1074	649
4.7	984	595

Columns – Allowable Concentric Axial Stresses and Loads

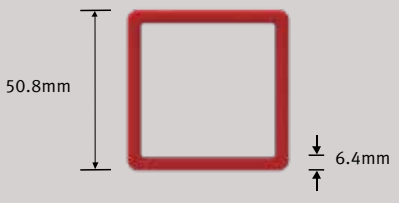
Part: 50.8 X 6.4mm		
Part Number: ARX-SH05106		
	A	1128.8mm ²
	r	18.3mm
Effective Length (m)	F _a (kPa)	P _a (N)
0.3	68900	77774
0.5	68900	77774
0.7	39263	44320
0.9	23752	26811
1.1	15900	17948
1.3	11384	12850
1.5	8551	9652
1.7	6657	7514
1.9	5329	6016
2.1	4363	4924
2.3	3637	4105
2.5	3078	3475
2.7	2639	2979
2.9	2288	2582
3.1	2002	2260
3.3	1767	1994
3.5	1571	1773
3.7	1405	1586
3.9	1265	1428
4.1	1145	1292
4.3	1041	1175
4.5	950	1072
4.7	871	983

Columns – Allowable Concentric Axial Stresses and Loads

Part: 50.8 X 9.5mm		
Part Number: ARX-SH05110		
	A	1572.2mm ²
	r	17.3mm
Effective Length (m)	F _a (kPa)	P _a (N)
0.3	68900	108325
0.5	68490	107679
0.7	34944	54938
0.9	21139	33234
1.1	14151	22248
1.3	10132	15929
1.5	7610	11964
1.7	5925	9315
1.9	4743	7457
2.1	3883	6104
2.3	3237	5089
2.5	2740	4307
2.7	2349	3693
2.9	2036	3201
3.1	1782	2801
3.3	1572	2472
3.5	1398	2198
3.7	1251	1966
3.9	1126	1770
4.1	1019	1601
4.3	926	1456
4.5	846	1329
4.7	775	1219

Columns – Allowable Concentric Axial Stresses and Loads

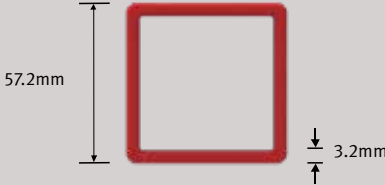
Part: 57.2 X 3.2mm		
Part Number: ARX-SH05703		
	A	685.3mm ²
	r	22.1mm
Effective Length (m)	F _a (kPa)	P _a (N)
0.3	48573	33287
0.5	48573	33287
0.7	48573	33287
0.9	34440	23602
1.1	23055	15799
1.3	16507	11312
1.5	12398	8497
1.7	9653	6615
1.9	7728	5296
2.1	6326	4335
2.3	5273	3614
2.5	4463	3059
2.7	3827	2622
2.9	3317	2273
3.1	2903	1989
3.3	2562	1756
3.5	2277	1561
3.7	2038	1396
3.9	1834	1257
4.1	1660	1137
4.3	1509	1034
4.5	1378	944
4.7	1263	865

Columns – Allowable Concentric Axial Stresses and Loads

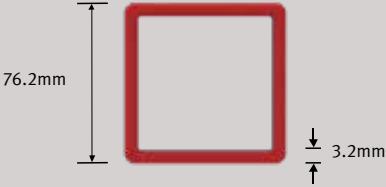
Part: 76.2 X 3.2mm		
Part Number: ARX-SH07603		
	A	927.2mm ²
	r	29.8mm
Effective Length (m)	F _a (kPa)	P _a (N)
0.3	28029	25988
0.5	28029	25988
0.7	28029	25988
0.9	28029	25988
1.1	28029	25988
1.3	28029	25988
1.5	22659	21009
1.7	17641	16357
1.9	14123	13094
2.1	11561	10719
2.3	9638	8936
2.5	8157	7563
2.7	6994	6484
2.9	6062	5621
3.1	5305	4919
3.3	4682	4341
3.5	4162	3859
3.7	3724	3453
3.9	3352	3108
4.1	3033	2812
4.3	2757	2557
4.5	2518	2334
4.7	2308	2140
4.9	2123	1969
5.1	1960	1817
5.3	1815	1683
5.5	1685	1563
5.7	1569	1455
5.9	1465	1358
6.1	1370	1270
6.3	1285	1191
6.5	1207	1119
6.7	1136	1053
6.9	1071	993
7.1	1011	938
7.3	957	887

Columns – Allowable Concentric Axial Stresses and Loads

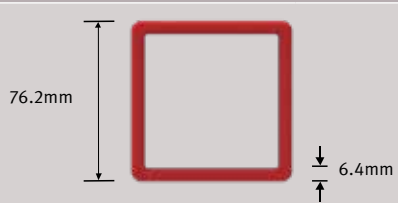
Part: 76.2 X 6.4mm		
Part Number: ARX-SH07606		
	A	1773.8mm ²
	r	28.6mm
Effective Length (m)	F _a (kPa)	P _a (N)
0.3	68900	122215
0.5	68900	122215
0.7	68900	122215
0.9	57954	102798
1.1	38795	68815
1.3	27777	49270
1.5	20863	37007
1.7	16243	28812
1.9	13003	23066
2.1	10645	18881
2.3	8874	15740
2.5	7511	13323
2.7	6439	11422
2.9	5582	9901
3.1	4885	8665
3.3	4311	7646
3.5	3832	6797
3.7	3429	6082
3.9	3086	5475
4.1	2793	4953
4.3	2539	4503
4.5	2318	4112
4.7	2125	3769
4.9	1955	3468
5.1	1805	3201
5.3	1671	2964
5.5	1552	2753
5.7	1445	2563
5.9	1349	2392
6.1	1262	2238
6.3	1183	2098
6.5	1111	1971
6.7	1046	1855
6.9	986	1749
7.1	931	1652
7.3	881	1563

Columns – Allowable Concentric Axial Stresses and Loads

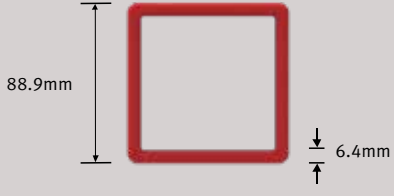
Part: 88.9 X 6.4mm		
Part Number: ARX-SH08906		
	A	2096.2mm ²
	r	33.8mm
Effective Length (m)	F _a (kPa)	P _a (N)
0.3	62358	130716
0.5	62358	130716
0.7	62358	130716
0.9	62358	130716
1.1	54059	113319
1.3	38705	81134
1.5	29072	60940
1.7	22634	47445
1.9	18120	37982
2.1	14833	31092
2.3	12365	25920
2.5	10466	21939
2.7	8973	18809
2.9	7778	16304
3.1	6807	14268
3.3	6007	12591
3.5	5340	11193
3.7	4778	10016
3.9	4301	9015
4.1	3891	8157
4.3	3538	7416
4.5	3230	6771
4.7	2961	6207
4.9	2724	5711
5.1	2515	5272
5.3	2329	4881
5.5	2162	4533
5.7	2013	4220
5.9	1879	3939
6.1	1758	3685
6.3	1648	3455
6.5	1548	3245
6.7	1457	3055
6.9	1374	2880
7.1	1298	2720
7.3	1228	2573
7.5	1163	2438
7.7	1103	2313
7.9	1048	2197

Columns – Allowable Concentric Axial Stresses and Loads

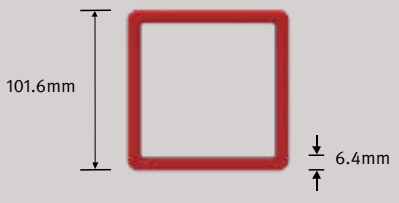
Part: 101.6 X 6.4mm		
Part Number: ARX-SH10206		
	A	2418.8mm ²
	r	39.0mm
Effective Length (m)	F _a (kPa)	P _a (N)
0.3	55493	134225
0.5	55493	134225
0.7	55493	134225
0.9	55493	134225
1.1	55493	134225
1.3	51455	124459
1.5	38648	93483
1.7	30090	72781
1.9	24088	58265
2.1	19719	47695
2.3	16438	39761
2.5	13913	33654
2.7	11929	28853
2.9	10340	25010
3.1	9049	21887
3.3	7985	19315
3.5	7099	17170
3.7	6352	15364
3.9	5717	13829
4.1	5173	12513
4.3	4703	11376
4.5	4294	10387
4.7	3937	9522
4.9	3622	8760
5.1	3343	8087
5.3	3096	7488
5.5	2875	6953
5.7	2677	6474
5.9	2498	6042
6.1	2337	5653
6.3	2191	5300
6.5	2058	4978
6.7	1937	4686
6.9	1827	4418
7.1	1725	4173
7.3	1632	3947
7.5	1546	3739
7.7	1467	3548
7.9	1393	3370

Columns – Allowable Concentric Axial Stresses and Loads

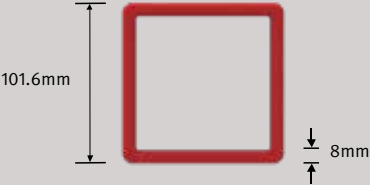
Part: 101.6 x 8mm		
Part Number: ARX-SH10208		
	A	2995.2mm ²
	r	38.4mm
Effective Length (m)	F _a (kPa)	P _a (N)
0.3	66478	199115
0.6	66478	199115
0.9	66478	199115
1.2	58466	175116
1.5	37418	112075
1.8	25985	77830
2.1	19091	57181
2.4	14616	43779
2.7	11549	34591
3.0	9355	28019
3.3	7731	23156
3.6	6496	19457
3.9	5535	16579
4.2	4773	14295
4.5	4158	12453

Columns – Allowable Concentric Axial Stresses and Loads

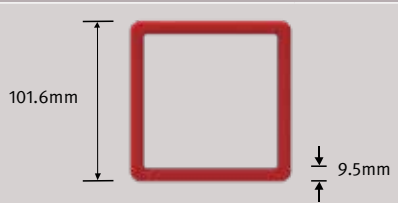
Part: 101.6 x 9.5mm		
Part Number: ARX-SH10210		
	A	3507.2mm ²
	r	37.8mm
Effective Length (m)	F _a (kPa)	P _a (N)
0.3	68900	241646
0.5	68900	241646
0.7	68900	241646
0.9	68900	241646
1.1	67574	236995
1.3	48381	169683
1.5	36340	127451
1.7	28292	99226
1.9	22649	79436
2.1	18541	65026
2.3	15456	54209
2.5	13082	45882
2.7	11216	39337
2.9	9722	34098
3.1	8508	29840
3.3	7508	26333
3.5	6675	23409
3.7	5973	20947
3.9	5376	18854
4.1	4864	17059
4.3	4422	15509
4.5	4038	14161
4.7	3701	12982
4.9	3405	11944
5.1	3144	11025
5.3	2911	10209
5.5	2703	9480
5.7	2517	8826
5.9	2349	8238
6.1	2197	7707
6.3	2060	7225
6.5	1935	6787
6.7	1821	6388
6.9	1717	6023
7.1	1622	5689
7.3	1534	5381
7.5	1454	5098
7.7	1379	4837
7.9	1310	4595

Columns – Allowable Concentric Axial Stresses and Loads

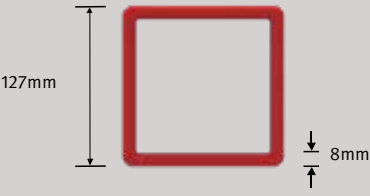
Part: 127 x 8mm		
Part Number: ARX-SH12708		
	A	3808.0mm ²
	r	48.7mm
Effective Length (m)	F _a (kPa)	P _a (N)
0.3	55493	211315
0.6	55493	211315
0.9	55493	211315
1.2	55493	211315
1.5	55493	211315
1.8	41885	159498
2.1	30773	117182
2.4	23560	89718
2.7	18616	70888
3.0	15079	57419
3.3	12462	47454
3.6	10471	39875
3.9	8922	33976
4.2	7693	29296
4.5	6702	25520

Columns – Allowable Concentric Axial Stresses and Loads

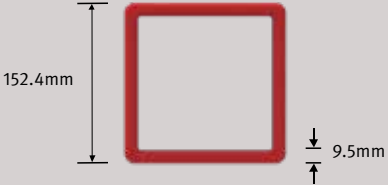
Part: 152.4 x 9.5mm		
Part Number: ARX-SH15210		
	A	5442.2mm ²
	r	58.5mm
Effective Length (m)	F _a (kPa)	P _a (N)
0.3	54914	298855
0.5	54914	298855
0.7	54914	298855
0.9	54914	298855
1.1	54914	298855
1.3	54914	298855
1.5	54914	298855
1.7	54914	298855
1.9	54199	294960
2.1	44367	241453
2.3	36986	201287
2.5	31305	170369
2.7	26839	146064
2.9	23265	126612
3.1	20360	110802
3.3	17967	97778
3.5	15972	86923
3.7	14292	77780
3.9	12864	70007
4.1	11639	63344
4.3	10582	57588
4.5	9662	52583
4.7	8857	48203
4.9	8149	44349
5.1	7522	40938
5.3	6965	37907
5.5	6468	35200
5.7	6022	32773
5.9	5621	30589
6.1	5258	28616
6.3	4930	26828
6.5	4631	25203
6.7	4359	23720
6.9	4110	22365
7.1	3881	21123
7.3	3672	19981
7.5	3478	18930
7.7	3300	17959
7.9	3135	17062



Rectangular Hollow Section

Columns – Allowable Concentric Axial Stresses and Loads

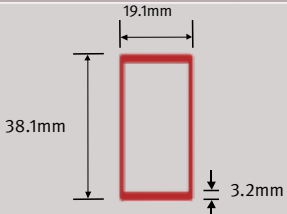
Part: 38.1 x 19.1 x 3.2mm		
Part Number: ARX-RH03801903		
	A	322.5mm ²
	r	7.2mm
Effective Length (m)	F _a (kPa)	P _a (N)
0.3	32599	10513
0.5	11736	3785
0.7	5988	1931
0.9	3622	1168
1.1	2425	782
1.3	1736	560
1.5	1304	421
1.7	1015	327

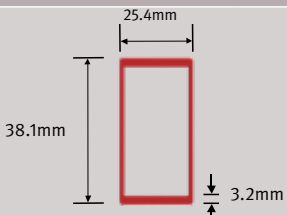
Part: 38.1 x 25.4 x 3.2mm		
Part Number: ARX-RH03802503		
	A	362.8mm ²
	r	9.6mm
Effective Length (m)	F _a (kPa)	P _a (N)
0.3	59141	21456
0.5	21291	7724
0.7	10863	3941
0.9	6571	2384
1.1	4399	1596
1.3	3150	1143
1.5	2366	858
1.7	1842	668
1.9	1474	535
2.1	1207	438
2.3	1006	365

Columns – Allowable Concentric Axial Stresses and Loads

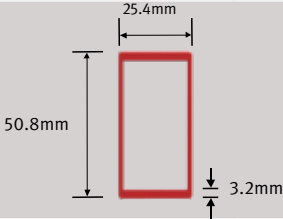
Part: 50.8 x 25.4 x 3.2mm		
Part Number: ARX-RH05102503		
	A	443.4mm ²
	r	10.0mm
Effective Length (m)	F _a (kPa)	P _a (N)
0.3	63098	27978
0.5	22715	10072
0.7	11589	5139
0.9	7011	3109
1.1	4693	2081
1.3	3360	1490
1.5	2524	1119
1.7	1965	871
1.9	1573	698
2.1	1288	571
2.3	1074	476

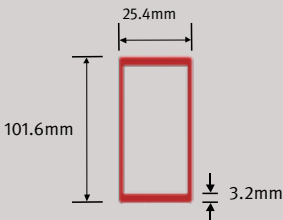
Part: 101.6 x 25.4 x 3.2mm		
Part Number: ARX-RH10202503		
	A	765.9mm ²
	r	10.5mm
Effective Length (m)	F _a (kPa)	P _a (N)
0.3	68900	52771
0.5	25071	19202
0.7	12791	9797
0.9	7738	5927
1.1	5180	3967
1.3	3709	2841
1.5	2786	2134
1.7	2169	1661
1.9	1736	1330
2.1	1421	1089
2.3	1185	908

Columns – Allowable Concentric Axial Stresses and Loads

Part: 101.6 x 3.2 x 50.8 x 6.4mm		
Part Number: ARX-RH10205106		
	A	1209.4mm ²
	r	19.5mm
Effective Length (m)	F _a (kPa)	P _a (N)
0.3	55493	67113
0.5	55493	67113
0.7	44367	53657
0.9	26839	32459
1.1	17967	21729
1.3	12864	15557
1.5	9662	11685
1.7	7522	9098
1.9	6022	7283
2.1	4930	5962
2.3	4110	4970
2.5	3478	4207
2.7	2982	3607
2.9	2585	3126
3.1	2262	2736
3.3	1996	2414
3.5	1775	2146
3.7	1588	1921
3.9	1429	1729
4.1	1293	1564
4.3	1176	1422
4.5	1074	1298

Columns – Allowable Concentric Axial Stresses and Loads

Part: 111.1 x 3.2 x 34.9 x 4.8mm		
Part Number: ARX-RH1103505		
	A	977.6mm ²
	r	14.2mm
Effective Length (m)	F _a (kPa)	P _a (N)
0.3	68900	67357
0.5	46127	45094
0.7	23534	23007
0.9	14237	13918
1.1	9530	9317
1.3	6824	6671
1.5	5125	5010
1.7	3990	3901
1.9	3194	3123
2.1	2615	2556
2.3	2180	2131
2.5	1845	1804
2.7	1582	1546
2.9	1371	1341
3.1	1200	1173
3.3	1059	1035

Columns – Allowable Concentric Axial Stresses and Loads

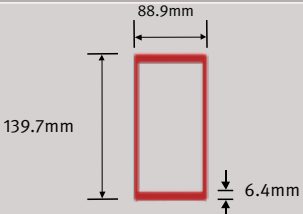
Part: 139.7 x 88.9 x 6.4mm		
Part Number: ARX-RH14008906		
	A	2741.2mm ²
	r	35.7mm
Effective Length (m)	F _a (kPa)	P _a (N)
0.3	62358	170937
0.5	62358	170937
0.7	62358	170937
0.9	62358	170937
1.1	60344	165416
1.3	43205	118434
1.5	32452	88957
1.7	25265	69257
1.9	20226	55444
2.1	16557	45386
2.3	13803	37836
2.5	11683	32025
2.7	10016	27456
2.9	8682	23799
3.1	7598	20828
3.3	6705	18380
3.5	5961	16339
3.7	5334	14620
3.9	4801	13159
4.1	4344	11907
4.3	3949	10825
4.5	3606	9884
4.7	3305	9061
4.9	3041	8336
5.1	2807	7695
5.3	2599	7125
5.5	2414	6617
5.7	2247	6161
5.9	2098	5750
6.1	1962	5379
6.3	1840	5043
6.5	1728	4737
6.7	1627	4459
6.9	1534	4204
7.1	1449	3971
7.3	1370	3756
7.5	1298	3558
7.7	1232	3376
7.9	1170	3207

Columns – Allowable Concentric Axial Stresses and Loads

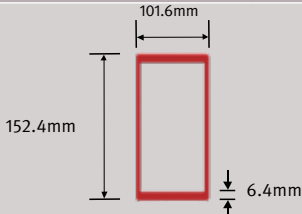
Part: 152.4 x 101.6 x 6.4mm		
Part Number: ARX-RH15210206		
	A	3063.8mm ²
	r	41.0mm
Effective Length (m)	F _a (kPa)	P _a (N)
0.3	55493	170018
0.5	55493	170018
0.7	55493	170018
0.9	55493	170018
1.1	55493	170018
1.3	55493	170018
1.5	42681	130765
1.7	33229	101807
1.9	26602	81502
2.1	21776	66717
2.3	18153	55619
2.5	15365	47076
2.7	13173	40360
2.9	11419	34985
3.1	9993	30616
3.3	8818	27018
3.5	7839	24018
3.7	7015	21492
3.9	6314	19344
4.1	5713	17503
4.3	5194	15913
4.5	4742	14530
4.7	4347	13319
4.9	4000	12254
5.1	3692	11312
5.3	3419	10474
5.5	3175	9726
5.7	2956	9056
5.9	2759	8452
6.1	2581	7907
6.3	2420	7413
6.5	2273	6964
6.7	2139	6554
6.9	2017	6180
7.1	1905	5837
7.3	1802	5521
7.5	1707	5231
7.7	1620	4962
7.9	1539	4714

SPACE GASS Input Guide

SPACE GASS Input Guide

With the increasing popularity of SPACE GASS with the engineering and planning community at large, Treadwell is aware that it essential to aid users and make usage of this multi-purpose 3D analysis and design program simpler with our product guide. Instructions are tabulated step by step below on how to use our tables with the program.

Instructions

Under the Section segment:

On the second line:

1. **A** refers to Cross Sectional Area found in all products under Sectional Properties.
2. **J** refers to Torsion Constant found in all products under Sectional Properties.
3. **I_y** refers to moment of inertia about the Y axis found in all products under Sectional Properties.
4. **I_z** refers to moment of inertia about the X axis found in all products under Sectional Properties.
5. **A_y** refers to shear area. This can be left as zero.
6. **A_z** refers to shear area. This can be left as zero.
7. **Alpha** does not need to be altered.
8. **Mark** refers to section mark. This is not important for design.

Under the Material segment:

1. The first box refers to the material number.
2. The second box refers to the material name.
3. E refers to the Modulus of Elasticity found on pages 10 & 12 under Coupon Properties.
4. Poisson's refers to the Poisson's Ratio of FRP which is 0.23.
5. Mass Density refers to Density found on pages 10 & 12 under Coupon Properties.
6. Temp. Coefficient refers to the Coefficient of Thermal Expansion, LW, found on pages 10 & 12 under Coupon Properties.
7. F_c refers to the compressive strength of concrete which is 0.

Edit/Query Member														
Member:	1	Type	Normal	Cable Len	0	Chord Length	10	Angle	Direction: 0	Node	N/A	Axis	N/A	Close
End A:	1	Fixity	FFFFFF	Trans	x y z	Rot	x y z	y Stiffness	z Stiffness					Cancel
End B:	2	Fixity	FFFFFF	Trans	x y z	Rot	x y z							Results
Section:	1	Source	Manual	Flip No		Angle Type	N/A							Help
	A	J	I _y	I _z	A _y	A _z	Alpha	Mark						Regen
	0	0	0	0	0	0	0							
Material:	1	E	Poisson's	Mass Dens	Temp Coeff	F _c								
		0	0	0	0	0								

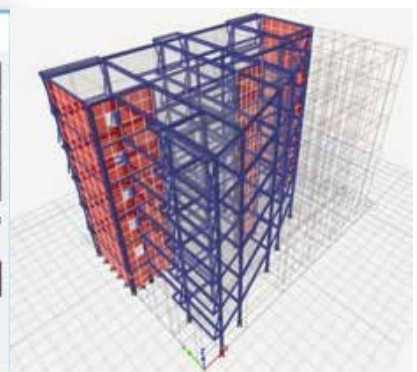

Corrosion Guide

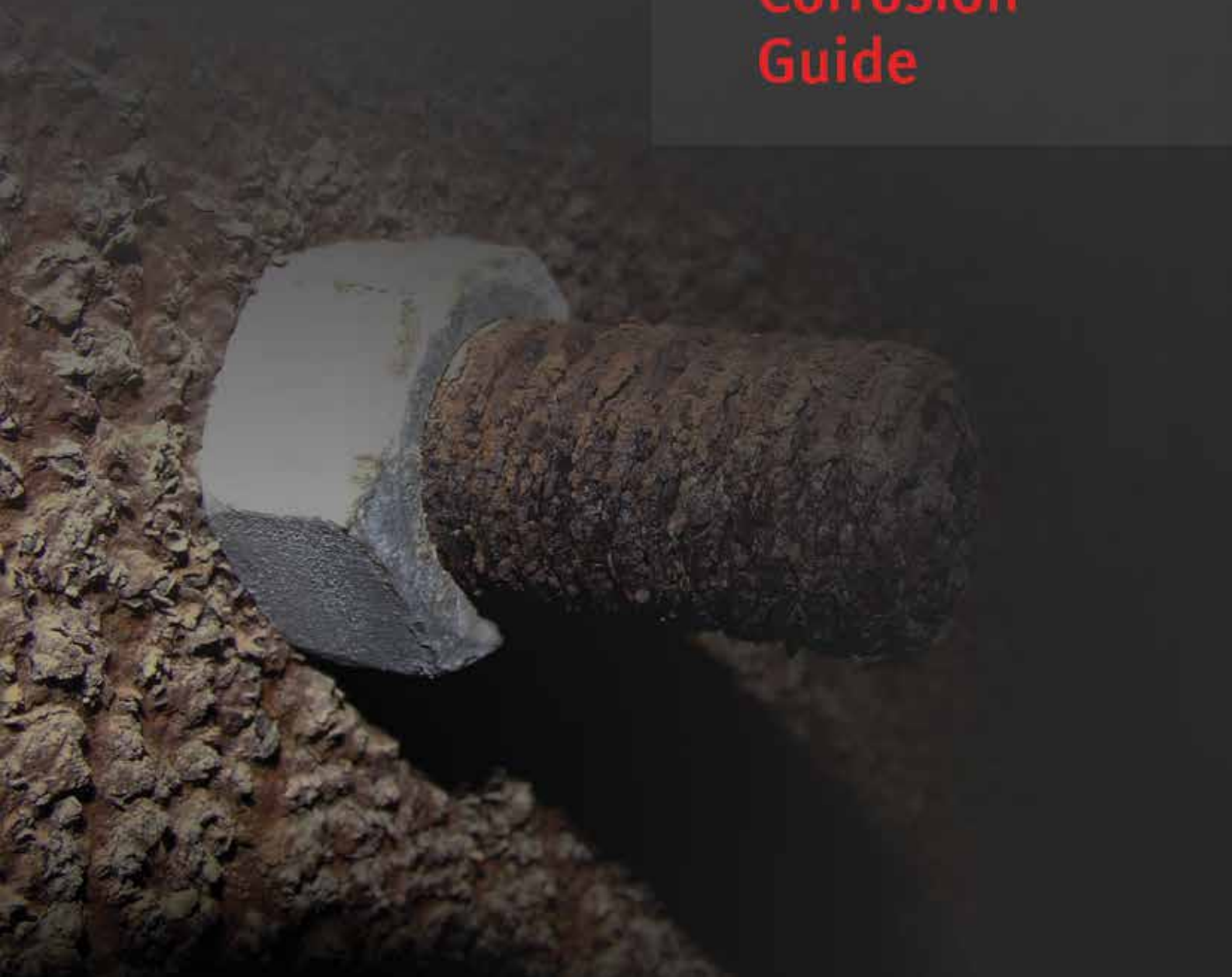

Corrosion Guide

Information contained in this guide is based on data collected from several years of actual industrial applications. Recommendations are based on conservative evaluations of the changes which occur in certain properties of replicate laminates after exposures of one year or longer, both in the laboratory and the field.

Temperatures are neither the minimum nor the maximum but represent standard test conditions (Room Temperature & 70°C). The products may be suitable at higher temperatures but individual test data should be

required to establish such suitability. Contact Treadwell for any special applications that you may have.

The recommendations (• : resistant – :not resistant) contained in this specification sheet are made without guarantee or representation as to results. We suggest that you evaluate these recommendations and suggestions in your own laboratory or actual field trial prior to use. Our responsibility for claims arising from breach of warranty, negligence, or otherwise **is limited to the purchase price of the material.**

Chemical	I-Series®		V-Series®	
	Room Temp	70°C	Room Temp	70°C
Acetaldehyde	—	—	—	—
Acetic Acid 0-25%	•	•	•	•
Acetic Acid 25-50%	•	—	•	•
Acetic Anhydride	—	—	—	—
Acetone	—	—	—	—
Acrylonitrile	—	—	—	—
Alcohol, Butyl	—	—	•	—
Alcohol, Ethyl 10%	—	—	•	66
Alcohol, Ethyl 100%	—	—	•	—
Alcohol, Isopropyl 10%	—	—	•	66
Alcohol, Isopropyl 100%	—	—	•	—
Alcohol, Methyl 10%	—	—	•	66
Alcohol, Methyl 100%	—	—	—	—
Alcohol, Methyl Isobutyl	—	—	•	66
Alcohol, Secondary Butyl	—	—	•	66
Aluminium	•	•	•	•
Aluminium Chloride	•	•	•	•
Aluminium Hydroxide	•	—	•	49
Aluminium Nitrate	•	•	•	•
Aluminium Potassium Sulfate	•	•	•	•
Ammonia, Aqueous 0-10%	—	—	•	38
Ammonia, Gas	—	—	•	38
Ammonium Bicarbonate	•	—	•	49
Ammonium Bisulfite	—	—	•	49
Ammonium Carbonate	—	—	•	49
Ammonium Citrate	•	—	•	49
Ammonium Fluoride	—	—	•	49
Ammonium Hydroxide 5%	•	—	•	49
Ammonium Hydroxide 10%	•	—	•	49
Ammonium Hydroxide 20%	—	—	•	49
Ammonium Nitrate	•	•	•	49
Ammonium Persulfate	—	—	•	49
Ammonium Phosphate	—	—	•	49
Ammonium Sulfate	•	•	•	•
Arsenious Sulfate	•	—	•	•
O-Benzoyl Benzoic Acid	—	—	•	•
Barium Carbonate	•	—	•	•

Chemical	I-Series®		V-Series®	
	Room Temp	70°C	Room Temp	70°C
Barium Chloride	•	—	•	•
Barium Hydroxide	—	—	•	49
Barium Sulfate	•	•	•	•
Barium Sulfide	—	—	•	•
Beer	•	—	•	49
Benzene	—	—	—	—
5% Benzene in Kerosene	•	—	•	•
Benzene Sulfonic Acid	•	•	•	•
Benzoic Acid	•	—	•	•
Benzyl Alcohol	—	—	•	—
Benzyl Chloride	—	—	—	—
Brass Plating Solution:				
– 3% Copper Cyanide	—	—	•	•
– 6% Sodium Cyanide	—	—	•	•
– 1% Zinc Cyanide	—	—	•	•
– 3% Sodium Carbonate	—	—	•	•
Butyl Acetate	—	—	—	—
Butyric Acid 0-50%	•	—	•	•
Butylene Glycol	•	•	•	•
Cadmium Chloride	•	—	•	•
Cadmium Cyanide Plating Soln:				
– 3% Cadmium Oxide	—	—	•	49
– 6% Sodium Cyanide	—	—	•	49
– 1% Caustic Soda	—	—	•	49
Calcium Bisulfate	•	•	•	•
Calcium Carbonate	•	—	•	•
Calcium Chlorate	•	•	•	•
Calcium Chloride	•	•	•	•
Calcium Hydroxide	•	—	•	49
Calcium Hypochlorite	•	—	•	49
Calcium Nitrate	•	•	•	•
Calcium Sulfate	•	•	•	•
Calcium Sulfite	•	•	•	•
Caprylic Acid	•	—	•	•
Carbon Dioxide	•	•	•	•
Glycerine	•	•	•	•
Glycol, Ethylene	•	•	•	•

Chemical	I-Series®		V-Series®	
	Room Temp	70°C	Room Temp	70°C
Glycol, Propylene	•	•	•	•
Glycolic Acid	•	—	•	•
Gold Plating Solution:				
– 63% Potassium Ferrocyanide	—	—	•	•
– 2% Potassium Gold Cyanide	—	—	•	•
– 8% Sodium Cyanide	—	—	•	•
Heptane	•	—	•	•
Hexane	•	—	•	•
Hexylene Glycol	•	•	•	•
Hydraulic Fluid	•	—	•	•
Hydrobromic Acid 0-25%	•	—	•	•
Hydrochloric Acid 0-37%	•	—	•	•
Hydrocyanic Acid	•	—	•	•
Hydrofluoric Acid 10%	—	—	•	—
Hydrofluosilicic Acid, 10%	—	—	•	•
Hydrogen Bromide, Wet Gas	—	—	•	•
Hydrogen Chloride, Dry Gas	—	—	•	•
Hydrogen Chloride, Wet Gas	—	—	•	•
Hydrogen Peroxide	—	—	•	49
Hydrogen Sulfide, Dry	•	—	•	•
Hydrogen Sulfide, Aqueous	•	—	—	•
Hydrogen Fluoride, Vapour	—	—	•	•
Hydrosulfite Bleach	—	—	•	49
Hydrochlorus Acid 0-10%	—	—	—	—
Iron Plating Solution:				
– 45% Fecl: 15% Cacl	—	—	•	•
– 20% Fecl: 11% (Nh4)2 So4	—	—	•	•
Iron And Steel Cleaning Bath:				
–9% Hydrochloric: 23% Sulfuric	—	—	•	•
Isopropyl Amine	—	—	•	38
Isopropyl Palmitate	•	•	•	•
Jet Fuel	•	—	•	•
Kerosene	•	—	•	•
Lactic Acid	•	—	•	•
Lauroryl Chloride	—	—	•	•
Lauric Acid	•	—	•	•
Lead Acetate	•	—	•	•
Lead Chloride	•	—	•	•
Lead Nitrate	•	—	•	•
Lead Plating Solution:				
–.8% Fluoboric, 0.4% Boric Acid	—	—	•	•
Levulinic Acid	•	—	•	•
Linseed Oil	•	•	•	•
Lithium Bromide	•	•	•	•
Lithium Sulfate	•	•	•	•

Chemical	I-Series®		V-Series®	
	Room Temp	70°C	Room Temp	70°C
Magnesium Bisulfite	•	—	•	•
Magnesium Carbonate	•	—	•	•
Magnesium Chloride	•	•	•	•
Magnesium Hydroxide	—	—	•	60
Magnesium Nitrate	•	—	•	•
Magnesium Sulfate	•	•	•	•
Maleic Acid	•	•	•	•
Mercuric Chloride	•	—	•	•
Mercurous Chloride	•	—	•	•
Methylene Chloride	—	—	—	—
Methyl Ethyl Ketone	—	—	—	—
Methyl Isobutyl Carbitol	—	—	—	—
Methanol (See Alcohol)	•	—	•	•
Methyl Isobutyl Ketone	—	—	—	—
Methyl Styrene	—	—	—	—
Mineral Oils	•	•	•	•
Molybdenum Disulfide	•	—	•	•
Monochloro Acetic Acid	—	—	—	—
Monoethanolamine	—	—	—	—
Motor Oil	•	•	•	•
Myristic Acid	—	—	•	•
Naptha	•	•	•	•
Napthalene	•	—	•	•
Nickel Chloride	•	•	•	•
Nickel Nitrate	•	•	•	•
Nickel Plating:				
– 8% Lead, 0.8% Flouboric Acid	—	—	•	•
– 0.4% Boric Acid	—	—	•	•
Nickel Plating:				
– 11% Nickel Sulfate	•	—	•	•
– 2% Nickel Chloride	•	—	•	•
– 1% Boric Acid	•	—	•	•
Nickel Plating:				
– 44% Nickel Sulfate	•	—	•	•
– 4% Ammonium Chloride	•	—	•	•
– 4% Boric Acid	•	—	•	•
Nickel Sulfate	•	•	•	•
Nitric Acid 0-5%	•	•	•	•
Nitric Acid 20%	—	—	•	49
Nitric Acid Fumes	—	—	—	—
Nibrobenzene	—	—	—	—
Octanoci Acid	•	—	•	•
Oil, Sour Crude	•	•	•	•
Oil, Sweet Crude	•	•	•	•
Oleic Acid	•	•	•	•

Corrosion Guide

Chemical	I-Series®		V-Series®	
	Room Temp	70°C	Room Temp	70°C
Oleum (Fuming Sulfuric)	—	—	—	—
Olive Oil	•	•	•	•
Oxalic Acid	•	•	•	•
Peroxide Bleach:				
– 25% Peroxide 95%	•	•	•	•
– 0.025% Epsom Salts	•	•	•	•
– 5% Sodium Silicate 42.Be	•	•	•	•
– 1.4% Sulfuric Acid 66.Be	•	•	•	•
Phenol	—	—	—	—
Phenol Sulfonic Acid	—	—	—	—
Phosphoric Acid	•	•	•	•
Phosphoric Acid Fumes	•	•	•	•
Phosphorous Pentoxide	•	•	•	•
Phosphorous Trichloride	—	—	—	—
Phthalic Acid	•	•	•	•
Pickling Acids(Sulfuric & Hydrochloric)	•	•	•	•
Picric Acid, Alcoholic	—	—	—	—
Polyvinyl Acetate Latex	•	—	•	•
Polyvinyl Alcohol	•	—	•	38
Polyvinyl Chloride Latex W/35(Parts Dop)	—	—	•	49
Potassium Aluminium Sulfate	•	•	•	•
Potassium Bicarbonate	•	—	•	60
Potassium Bromide	•	—	•	38
Potassium Carbonate	•	—	•	60
Potassium Chloride	•	•	•	•
Potassium Dichromate	•	—	•	60
Potassium Ferricyanide	•	•	•	•
Potassium Ferrocyanide	•	•	•	•
Potassium Hydroxide	—	—	•	66
Potassium Nitrate	•	•	•	•
Potassium Permanganate	•	—	•	60
Potassium Persulfate	•	—	•	•
Potassium Sulfate	•	•	•	•
Propionic Acid 1-50%	—	—	•	49
Propionic Acid 50-100%	—	—	—	—
Propylene Glycol	•	•	•	•
Pulp Paper Mill Effluent	•	—	•	•
Pyridine	—	—	—	—
Salicylic Acid	—	—	•	60
Sebacic Acid	—	—	•	•
Selenious Acid	—	—	•	•
Silver Nitrate	•	•	•	•
Silver Plating Solution:				
– 44% Silver Cyanide	—	—	•	•
– 7% Potassium Cyanide	—	—	•	•

Chemical	I-Series®		V-Series®	
	Room Temp	70°C	Room Temp	70°C
– 5% Sodium Cyanide	—	—	•	•
– 2% Potassium Carbonate	—	—	•	•
Soaps	•	—	•	•
Sodium Acetate	•	—	•	•
Sodium Benzoate	•	—	•	•
Sodium Bicarbonate	•	•	•	•
Sodium Bifluoride	•	—	•	49
Sodium Bisulfate	•	•	•	•
Sodium Bisulfite	•	•	•	•
Sodium Bromate	•	•	•	60
Sodium Bromide	•	•	•	•
Sodium Carbonate 0-25%	•	—	•	•
Sodium Chlorate	•	—	•	•
Sodium Chloride	•	•	•	•
Sodium Chlorite	•	—	•	•
Sodium Chromite	•	•	•	•
Sodium Cyanide	•	—	•	•
Sodium Dichromate	•	•	•	•
Sodium Di-Phosphate	•	•	•	•
Sodium Ferricyanide	•	•	•	•
Sodium Fluoride	•	—	•	49
Sodium Fluoro Silicate	—	—	•	49
Sodium Hexametaphosphates	—	—	•	38
Sodium Hydroxide 0-5%	—	—	•	66
Sodium Hydroxide 5-25%	—	—	•	66
Sodium Hydroxide 50%	—	—	•	66
Sodium Hydrosulfide	•	—	•	•
Sodium Hypochlorite	•	—	•	66
Sodium Lauryl Sulfate	•	•	•	•
Sodium Mono-Phosphate	•	•	•	•
Sodium Nitrate	•	•	•	•
Sodium Silicate	•	—	•	•
Sodium Sulfate	•	•	•	•
Sodium Sulfide	•	—	•	•
Sodium Sulfite	•	—	•	•
Sodium Tetra Borate	•	•	•	•
Sodium Thiocyanate	—	—	•	•
Sodium Thiosulfate	•	—	•	•
Sodium Tripolyphosphate	•	—	•	•
Sodium Xylene Sulfonate	•	—	•	•
Sodium Solutions	•	—	•	•
Sodium Crude Oil	•	•	•	•
Soya Oil	•	•	•	•
Stannic Chloride	•	•	•	•
Stannous Chloride	•	•	•	•

Chemical	I-Series®		V-Series®	
	Room Temp	70°C	Room Temp	70°C
Stearic Acid	•	•	•	•
Styrene	—	—	—	—
Sugar, Beet And Cane Liquor	•	—	•	•
Sugar, Sucrose	•	•	•	•
Sulfamic Acid	•	—	•	•
Sulfanilic Acid	•	—	•	•
Sulfated Detergents	•	—	•	•
Sulfur Dioxide, Dry Or Wet	—	—	•	•
Sulfur Trioxide/Air	—	—	•	•
Sulfuric Acid 0-30%	•	•	•	•
Sulfuric Acid 30-50%	—	—	•	•
Sulfuric Acid 50-70%	—	—	•	49
Sulfurous Acid	—	—	•	38
Superphosphoric Acid (76% P2 O5)	•	—	•	•
Tall Oil	•	—	•	60
Tannic Acid	•	—	•	66
Tartaric Acid	•	•	•	•
Thionyl Chloride	—	—	—	—
Tin Plating:				
– 18% Stannous Fluorborate	—	—	•	•
– 7% Tin	—	—	•	•
– 9% Fluorboric Acid	—	—	•	•
– 2% Boric Acid	—	—	•	•
Toluene	—	—	—	—
Toluene Sulfonic Acid	—	—	•	•
Transformer Oils:				
– Mineral Oil Types	•	•	•	•
– Chloro-Phenyl Types)	•	•	•	•
Trichlor Acetic Acid	•	—	•	•
Trichlorethylene	—	—	—	—
Trichloropenol	—	—	—	—
Tricresyl Phosphate	—	—	•	49
Tridecylbenzene Sulfonate	•	—	•	•
Trisodium Phosphate	•	—	•	•
Turpentine	—	—	•	38
Urea	—	—	•	38
Vegetable Oils	•	•	•	•
Vinegar	•	•	•	•
Vinyl Acetate	—	—	—	—
Water:				
– Deionised	—	—	—	—
– Demineralised	•	•	•	•
– Distilled	•	•	•	•
– Fresh	•	•	•	•
– Salt	•	•	•	•

Chemical	I-Series®		V-Series®	
	Room Temp	70°C	Room Temp	70°C
– Sea	•	•	•	•
White Liquor (Pulp Mill)	•	—	•	•
Xylene	—	—	—	—
Zinc Chlorate	•	•	•	•
Zinc Nitrate	•	•	•	•
Zinc Plating Solution:				
– 9% Zinc Cyanide	—	—	•	49
– 4% Sodium Cyanide	—	—	•	49
–9% Sodium Hydroxide	—	—	•	49
Zinc Plating Solution:				
– (49% Zinc Fluoroborate	•	—	•	•
– 5% Ammonium Chloride	•	—	•	•
– 6% Ammonium Fluoroborate	•	—	•	•
Zinc Sulfate	•	•	•	•

Colour Options

Our commonly stocked colours are Charcoal, Light Grey and Dark Grey. Custom colours are also available upon request. Contact Treadwell to discuss your colour requirements.

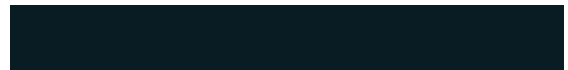

Charcoal



Light Grey



Dark Grey

Treadwell is able to produce pultrusions integrally pigmented to almost any colour specification. Information provided above is a guide only.

Notes

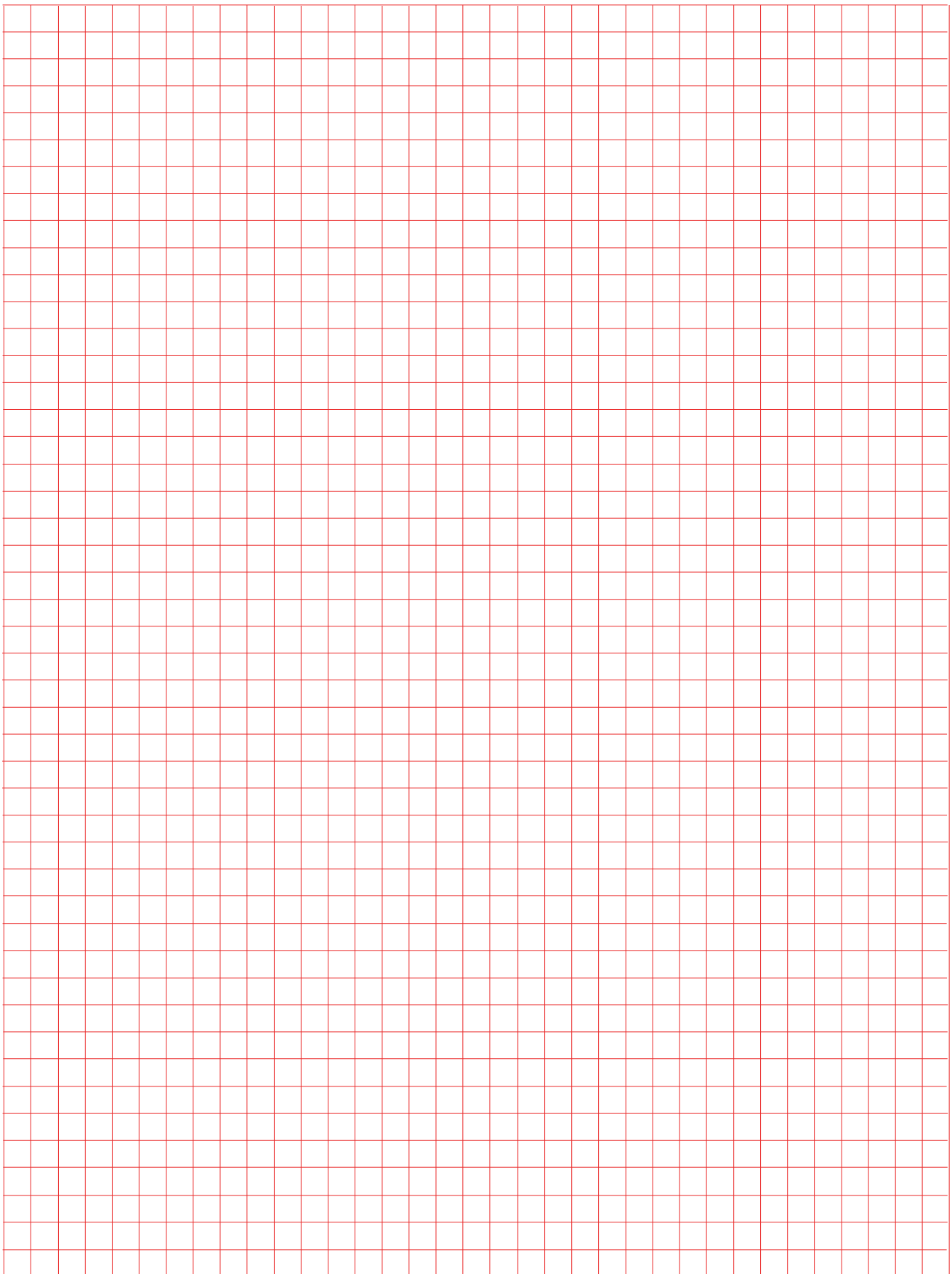

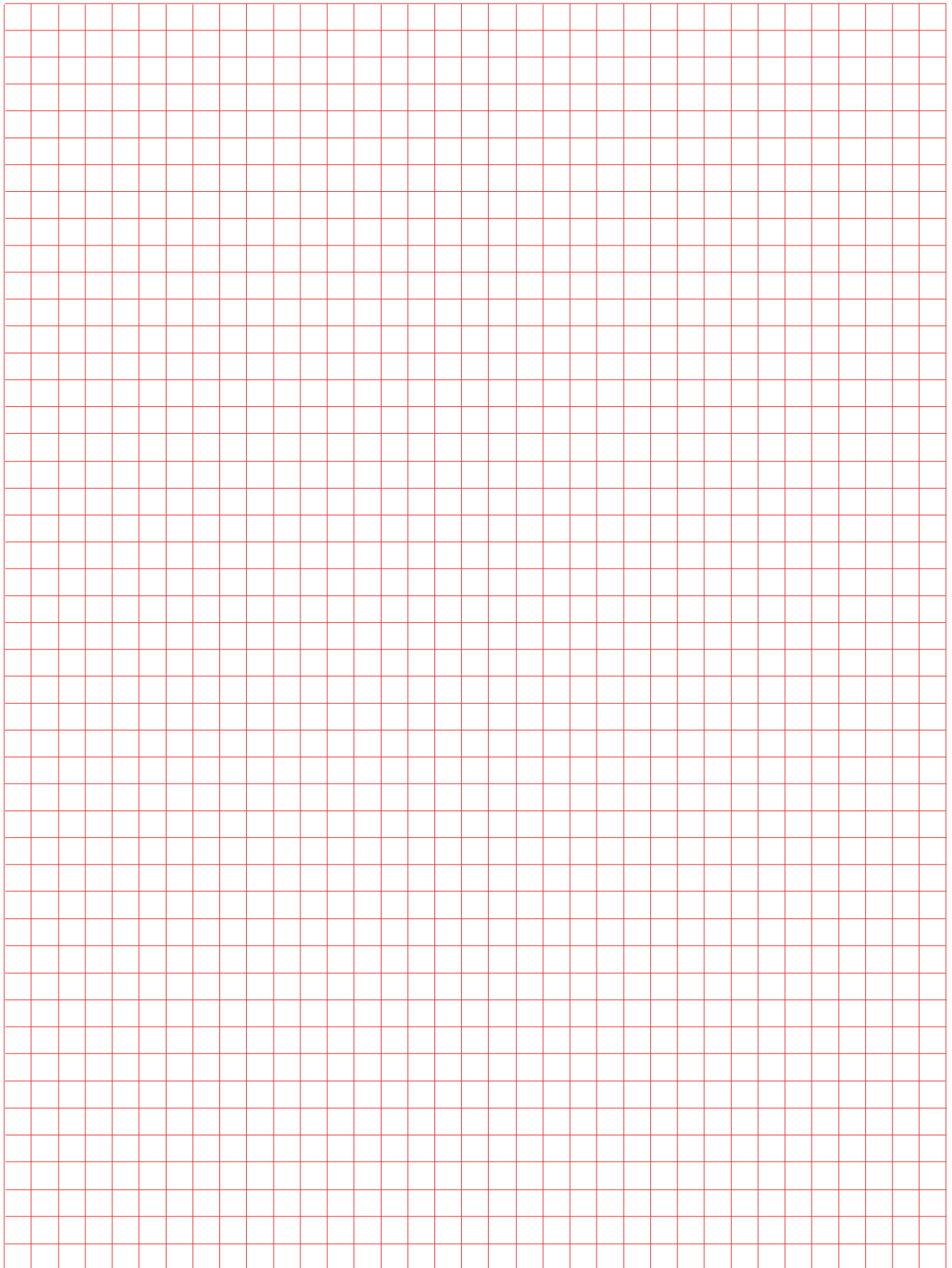

Notes

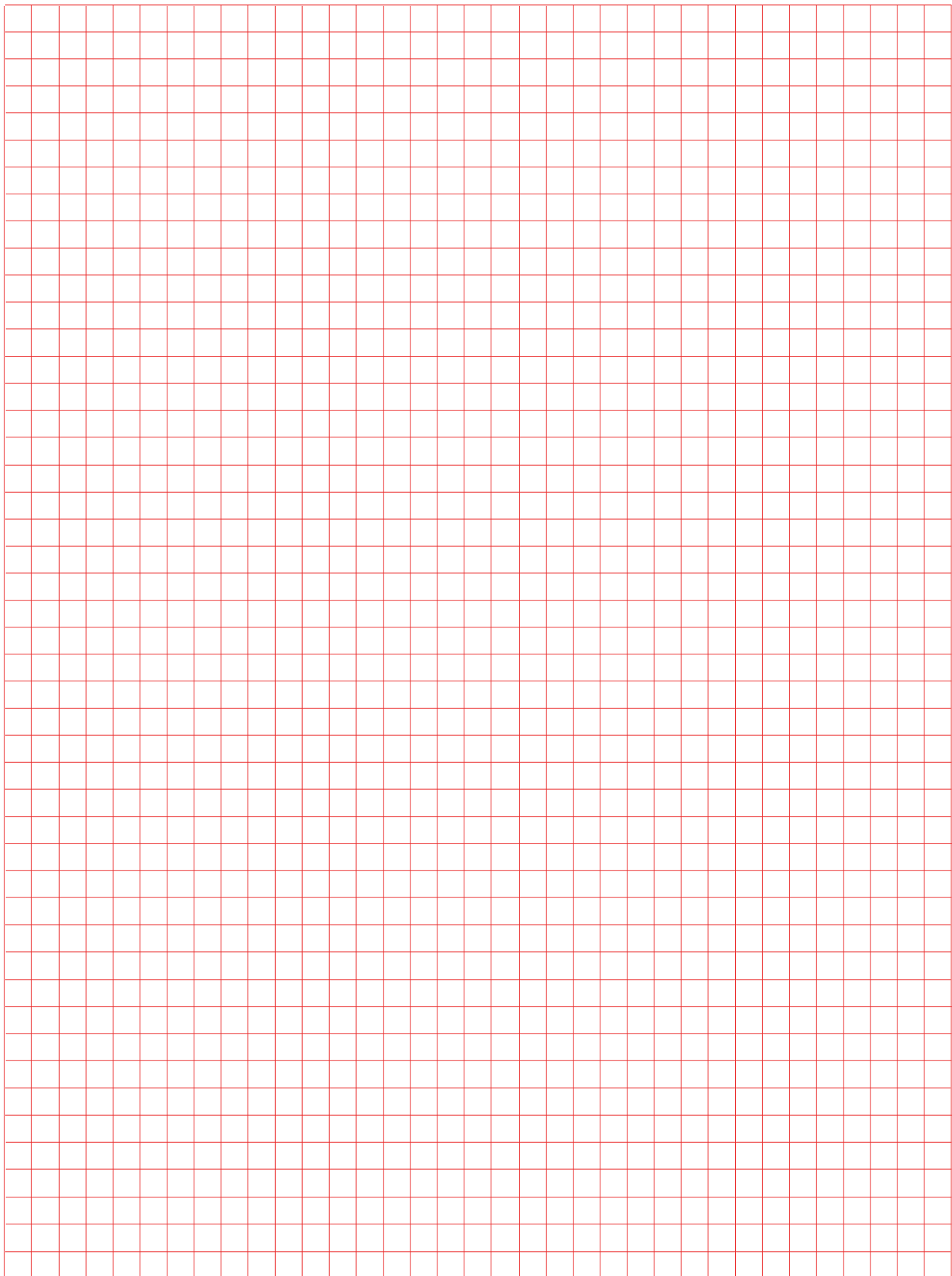



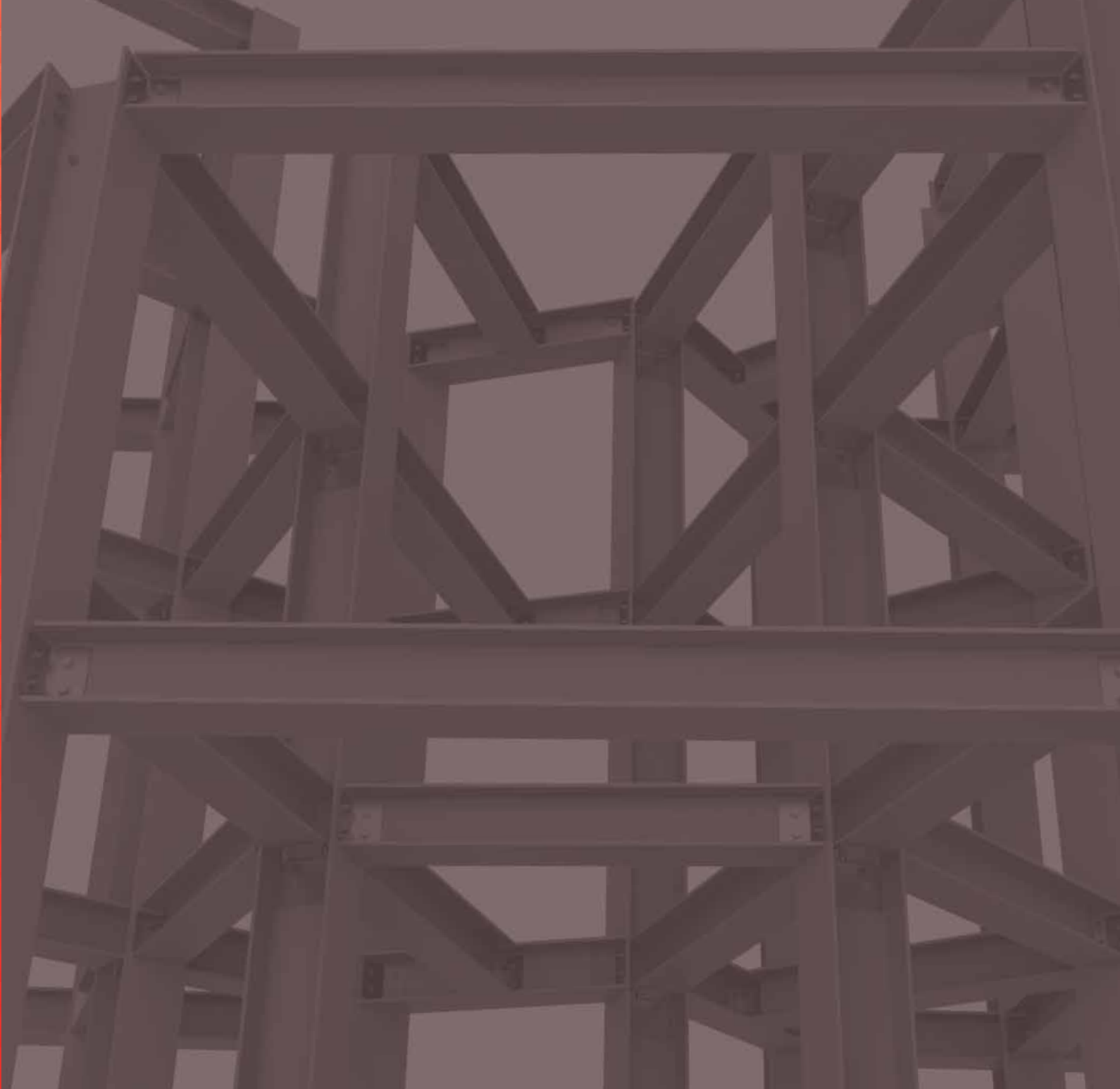
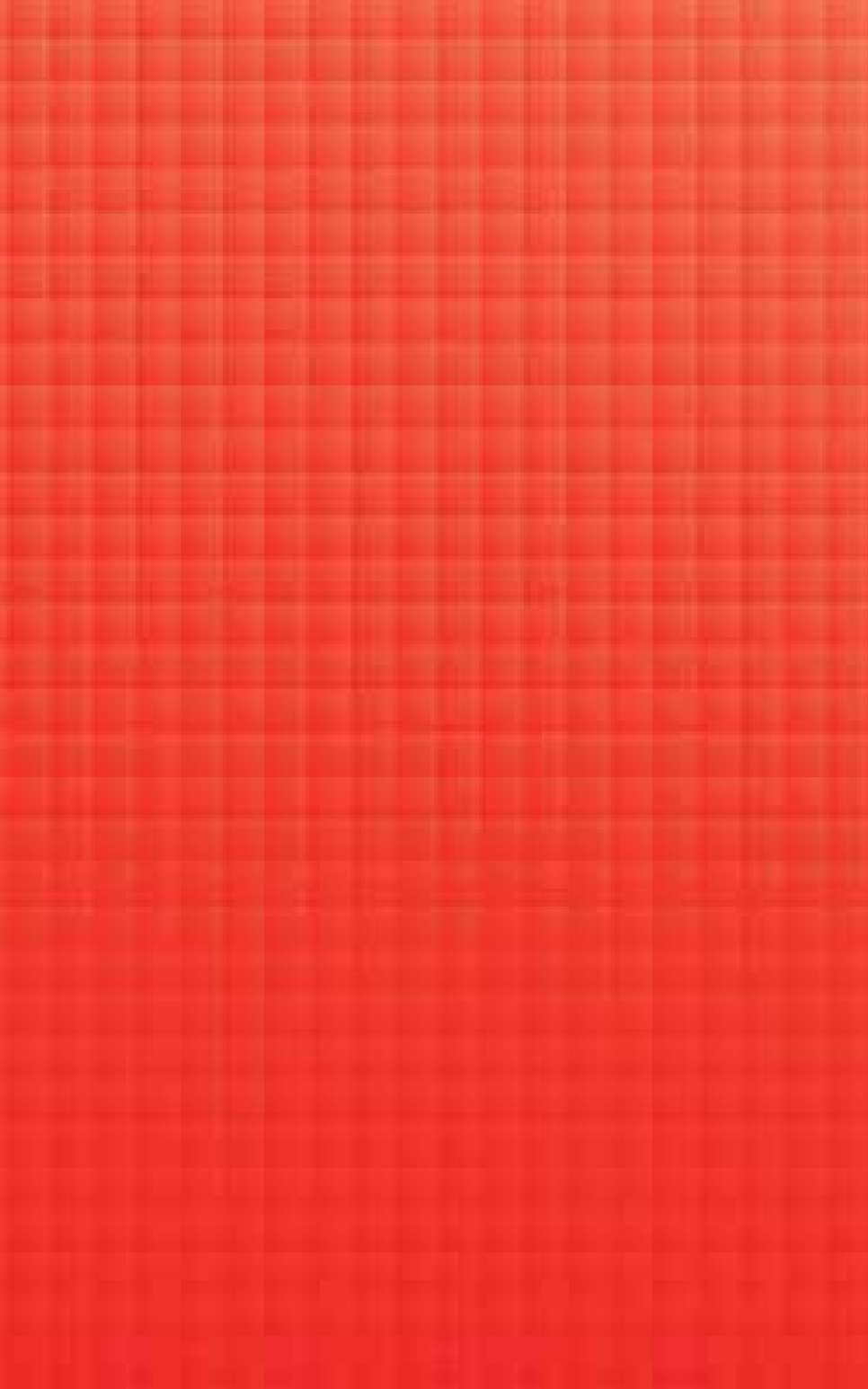

TREADWELL

Treadwell brands mentioned in this document are all registered brands of Treadwell Group Pty Ltd. All pictures and information are supplied as a guide only. The complete range of Treadwell products are developed, refined, made to meet and exceed stringent specifications for the worldwide market.

Important Note: Sales of products are subject to our Terms and Conditions which are available upon request. All specifications and photos are a guide only and are subject to change without notice. Please ring to confirm details. Treadwell products stated only comply with relevant standards mentioned within this publication when installed and used as they are designed to be.

